



























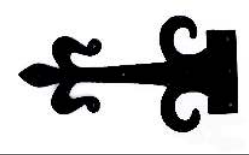

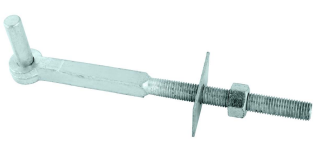

Other Product Range

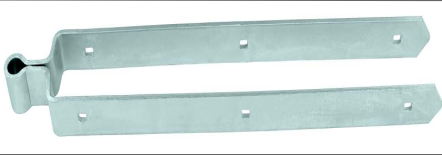
Hinges					
Aluminium					
Locks, Latches & Catches					
Stainless Steel & Zinc Die Cast Handle					
Black Antique & Brass					
Field Gate					
Miscellaneous					

Garg

ISO 9001 : 2008 CERTIFIED COMPANY

Ironmongery

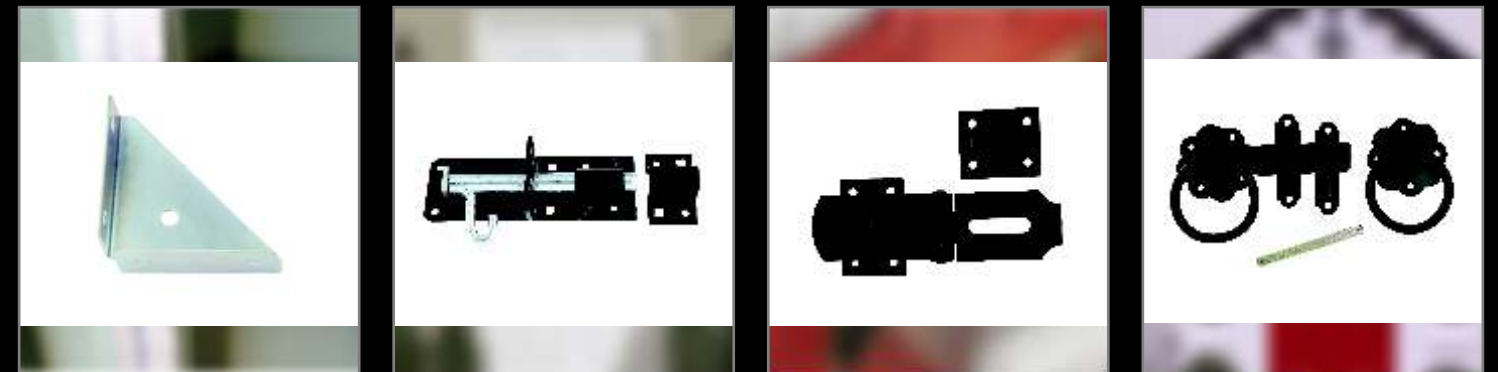

D. P. GARG & CO. PVT. LTD.

An ISO : 9001 : 2008 , 14001 : 2004, 18001 : 2007 Certified Company
 A Government of India Recognised Star Export House
 B-210 B, Phase - 2, Noida - 201305 (U.P.) INDIA
 Ph.: +91-120-2460071, 2460085 to 87 Fax : +91-120-2460083, 2424519, 2424452
 Email : smg@garg-hinges.com
 Visit us at : www.garg-hinges.com, www.garglocks.co.in , www.elitelocks.co.in



 Quality the World Trusts



IRONMONGERY FITTINGS

ITEM CODE	DESCRIPTION	PAGE No.	ITEM CODE	DESCRIPTION	PAGE No.
923SS	STAINLESS STEEL TOWER BOLT	01	1260HLK	STEEL LOCKING GARAGE DOOR BOLT	11
887SS	STAINLESS STEEL BOLT LIGHT 1.5"	01	597	STEEL CROSS DOOR BOLT	11
888SS	STAINLESS STEEL BOLT LIGHT 2"	01	6553	FIELD GATE SHOOT BOLT	12
889SS	STAINLESS STEEL BOLT LIGHT 2.5"	01	213	CANE BOLT	12
890SS	STAINLESS STEEL BOLT LIGHT 3"	01	7A	AUTO LOCK PIG BOLT	12
891SS	STAINLESS STEEL BOLT LIGHT 4"	01	1836	SPRING LOADED ANIMAL BOLT	13
892SS	STAINLESS STEEL BOLT LIGHT 6"	01	1835	SPRING LOADED ANIMAL BOLT C/W STAPLE	13
891HSS	STAINLESS STEEL BOLT HEAVY 4"	01	1819	AUTOMATIC GATE CATCH STEEL CASE & PEG	13
893SS	STAINLESS STEEL BOLT HEAVY 6"	01	1822	HVY. AUTOMATIC GATE CATCH STEEL CASE	
894SS	STAINLESS STEEL BOLT HEAVY 8"	01		MALLEABLE IRON PEG	13
895SS	STAINLESS STEEL BOLT HEAVY 10"	01		PEGS FOR AUTOMATIC GATE CATCH	14
888NSS	STAINLESS STEEL BARREL BOLT NECKED LIGHT 2"	02	20	STEEL SUFFOLK LATCH	14
889NSS	STAINLESS STEEL BARREL BOLT NECKED LIGHT 2.5"	02	54/4	STEEL SUFFOLK LATCH HEAVY	14
890NSS	STAINLESS STEEL BARREL BOLT NECKED LIGHT 3"	02	20/2	SPARES STEEL SUFFOLK LATCH (KEEP, CATCH & T BAR)	15
891NSS	STAINLESS STEEL BARREL BOLT NECKED LIGHT 4"	02	1136	STEEL GATE LATCH PLAIN RING HANDLE	15
892NSS	STAINLESS STEEL BARREL BOLT NECKED LIGHT 6"	02	1141	STEEL GATE LATCH TWISTED RING HANDLE	15
791NSS	STAINLESS STEEL BARREL BOLT NECKED HEAVY 4"	02	1136BR	STEEL GATE LATCH PLAIN BIG RING HANDLE	16
893NSS	STAINLESS STEEL BARREL BOLT NECKED HEAVY 6"	02	1136EH	EXTRA HVY STEEL GATE LATCH PLAIN BIG RING HANDLE	16
894NSS	STAINLESS STEEL BARREL BOLT NECKED HEAVY 8"	02	1136A	WENDY HOUSE LATCH	16
895NSS	STAINLESS STEEL BARREL BOLT NECKED HEAVY 10"	02	SPARES	RING ONLY	17
1261SS	STAINLESS STEEL CABIN HOOK	02	SPARES	RING GATE LATCH SPARES (KEEP & CATCH)	17
923A	STEEL TOWER BOLT	03	1131	SURFACE LATCH	17
923N	STEEL NECKED TOWER BOLT	03	500	STEEL DOOR SPRING	17
925	STEEL HIGH DOME TOWER BOLT	03	478A	CASEMENT STAY WITH 1 FLAT CENTRE & 1 OFFSET PIN)	18
923SA	BARREL BOLT	04	478B	CASEMENT STAY WITH 9 CENTRE & 9 OFFSET PIN(EJMA)	18
923H	STEEL SECTIONAL TOWER BOLT	04	478C	CASEMENT STAY (WITH 2 NOS. 5/16" PINS)	18
1258	BARREL BOLT	04	SPARES	PINS FOR CASEMENT STAY (OFFSET & CENTRE)	18
1258H	HEAVY BARREL BOLT	05	GZC2001	CASEMENT FASTENER (WEDGE)	19
SPARES	KEEPS FOR BOLT	05	GZC2031	LOCKING CASEMENT FASTENER	19
1A	STEEL HEAVY PADBOLT, BRENTON PATTERN	05	GZC2021	LOCKING CASEMENT STAY	19
2A	STEEL MEDIUM PADBOLT, BRENTON PATTERN	06	GZC2025	LOCKING CASEMENT STAY (MODERN)	19
4A	STEEL OVAL PADBOLT	06	497	TOP FLAP STAY	20
5A	DOOR BOLT FOR PADLOCK	06	498	SOLID LID STAY	20
6A	SLIMLINE PADBOLT	07	GZC3035	FITCH FASTENER	20
2ASA	MEDIUM PADBOLT	07	GZC2005	WINDOW FASTENER	20
4ASA	STEEL OVAL PADBOLT	07	GZC2071	SASH FASTENER	21
SPARES	KEEPS FOR BOLT	08	1261	STEEL WIRE CABIN HOOK	21
1257	STEEL SLIDING ACTION BOLT DOUBLE LOCKING	08	1262	STEEL EXTRA LONG CABIN HOOK	21
60BHB	STEEL BOW HANDLE BOLT	08	G0420	MALLEABLE CABIN HOOK SQUARE CAST PLATE	22
60MTB	STEEL MONKEY TAIL BOLT	09	G0421	MALLEABLE CABIN HOOK SQUARE CAST PLATE	22
66	STEEL CHAIN BOLT REVERSIBLE SPRING LOADED SHOOT	09	G2099	MALLEABLE CABIN HOOK OVAL PLATE	22
68	STEEL FOOT BOLT	09	G2100	MALLEABLE CABIN HOOK OVAL PLATE	22
482-485	ACCESSORIES FOR BOLTS	10	G2101	MALLEABLE CABIN HOOK OVAL PLATE	22
1259	DOOR BOLT	10	G2102	MALLEABLE CABIN HOOK OVAL PLATE	22
1260L	STEEL LT. GARAGE DOOR BOLT WITH RECEIVER PLATE	10	G2103	MALLEABLE CABIN HOOK OVAL PLATE	22
1260H	STEEL HEAVY GARAGE DOOR BOLT WITH RECEIVER PLATE	11	G2104	MALLEABLE CABIN HOOK OVAL PLATE	22
			G2099A	MALLEABLE CABIN HOOK OVAL PLATE WITH RING	22
			G2100A	MALLEABLE CABIN HOOK OVAL PLATE WITH RING	22

IRONMONGERY FITTINGS

ITEM CODE	DESCRIPTION	PAGE No.	ITEM CODE	DESCRIPTION	PAGE No.
G2101A	MALLEABLE CABIN HOOK OVAL PLATE WITH RING	22	258	STEEL TUBULAR HANDLE	34
G2102A	MALLEABLE CABIN HOOK OVAL PLATE WITH RING	22	258H	STEEL HEAVY PULL HANDLE	34
G2103A	MALLEABLE CABIN HOOK OVAL PLATE WITH RING	22	1100	HOT BED HANDLE 6"	34
G2104A	MALLEABLE CABIN HOOK OVAL PLATE WITH RING	22	1100A	HOT BED HANDLE 7"	34
G1800	TURN BUTTON	22	1100S	HOT BED HANDLE 5"	34
G1801	TURN BUTTON	22	1100B	HOT BED HANDLE 8"	34
G1802	TURN BUTTON	22	1100L	HOT BED HANDLE	35
G1803	TURN BUTTON	22	71705	DOOR STOPPER SMALL	35
149LW	WIRE HASP AND STAPLE LIGHT PATTERN	23	71706	DOOR STOPPER LARGE	35
149W	WIRE HASP AND STAPLE	23	70090	MINI MOUNT	35
617EL	STEEL SAFETY HASP AND STAPLE EXTRA LIGHT PATTERN	23	780	LARGE PATTERN TABLE BRACE PLATE	35
617	STEEL SAFETY HASP AND STAPLE	24	401	TWISTED SUPPORT BRACKET	35
149	STEEL SAFETY HASP AND STAPLE HEAVY PATTERN	24	GP039	SINGLE SCREW PULLEY	36
149M	STEEL SAFETY HASP AND STAPLE MEDIUM PATTERN	24	GP042	DOUBLE SCREW PULLEY	36
147	SWIVEL LOCKING BAR	25	GP260	SINGLE CLOTHES LINE PULLEY	36
146	VERTICAL HASP AND STAPLE	25	GP260A	SINGLE CLOTHES LINE PULLEY	36
GLH001	LOCKING HASP AND STAPLE	25	GP202A	AXLE PULLEY WITH PLATE, NYLON WHEEL FOREND	37
151LH/RH	PADLOCK PROTECTION BARS- LEFT/ RIGHT HANDED	25	GP202	AXLE PULLEY NYLON WHEEL	37
1010	GARAGE DOOR HOLDER SENIOR FOR WIDE LINTELS	26	GP202/O	ROUND END AXLE PULLEY CAST WHEEL	37
1011	GARAGE DOOR HOLDER FOR NARROW LINTELS	26	GP261	SINGLE LINE(AWNING) PULLEY	37
1012	GARAGE DOOR HOLDER JUNIOR FOR WIDE LINTELS	26	GP268	SINGLE UPRIGHT PULLEY-WHEEL ACROSS THE PLATE	38
SSB001	SHED SECURITY BAR	26	GP268A	SINGLE UPRIGHT PULLEY-WHEEL ALONG THE PLATE	38
236	HANDRAIL BRACKET	27	GP202C	CAST IRON SASH PULLEY CAST WHEEL	38
236FB	HANDRAIL BRACKET FIX BENDED (EURO)	27	GP202D	SASH PULLEY WITH BRASS WHEEL	38
236AB/AS	HANDRAIL BRACKET ADJUSTABLE BENDED/STRAIGHT	27	1581	FAST EYE PULLEY(NICKLE PLATED)	39
1247	FLUTED ANGLE BRACKET	28	1706	SPRING DOOR STOP	39
319L	STEEL CORNER BRACES LIGHT COUNTER SUNK	28	G0051	BLACK ANTIQUE RACK END (LIGHT WEIGHT)	39
319H	STEEL CORNER BRACES HEAVY COUNTER SUNK	28	G2001	CLEAT HOOK	39
319RC	ROUND CORNER BRACKET	29	G2002	CLEAT HOOK	39
218	STEEL STRETCHER PLATE (LIGHT)	29	G2003	CLEAT HOOK	39
315	STEEL STRETCHER PLATE	29	G2004	CLEAT HOOK	39
324	STEEL CORNER PLATE	29	G2005	CLEAT HOOK	39
318	STEEL TEE PLATE	30		ALPHABETICAL INDEX	40
325	STEEL MENDING PLATE	30		ALPHABETICAL INDEX	41
325H	HEAVY STEEL MENDING PLATE	30		NUMERICAL INDEX	42
316/317	STEEL SLOT PLATE HEAVY (HORIZONTAL/ VERTICAL)	31			
316A/317A	STEEL SLOT PLATE LIGHT (HORIZONTAL/ VERTICAL)	31			
70070	FLANGE BRACKET	31			
70080	CORNER BRACKET	32			
329	Z BRACKET	32			
326	CONNECTING BRACKET	32			
327	TWISTED BRACKET	32			
331	RIDGE PLATE	33			
585	MIRROR PLATE PLAIN	33			
585S	MIRROR PLATE SLOTTED	33			
790	QUADRANT STAY - LEFT HANDED/RIGHT HANDED	33			
246	STEEL CHEST HANDLE	34			

***NOTE : ALL WEIGHTS GIVEN IN KGS & LENGTHS IN MM UNLESS MENTIONED**



923SS : STAINLESS STEEL TOWER BOLT



ITEM CODE	SIZE	SHOOT LENGTH	LENGTH	Plate Width	SHOOT DIA	SCREW NO.	WT/PAIR	Prs In Inner	Prs In Outer
SHIN0923075	3"	75	75	33	10	4	0.084	10	240
SHIN0923100	4"	100	100	33	10	4	0.130	10	160
SHIN0923150	6"	150	150	33	10	4	0.158	10	140
SHIN0923200	8"	200	200	33	10	4	0.216	10	100
SHIN0923250	10"	250	250	33	10	6	0.252	10	80
SHIN0923300	12"	300	300	33	10	6	0.307	10	60

FINISH AVAILABLE - EB, SATIN, MIRROR POLISHED

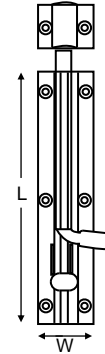

STAINLESS STEEL BARREL BOLT NECKED (LIGHT)



ITEM CODE	SIZE	SHOOT LENGTH	LENGTH	WIDTH	SHOOT DIA.	SCREW NO.	WT/PCS	Pcs In Inner	Pcs In Outer
SIRN888N050	2"	48	50	27	6.9	4	0.047	10	400
SIRN889N065	2.5"	63	65	27	6.9	4	0.056	10	340
SIRN890N075	3"	73	75	27	6.9	4	0.066	10	300
SIRN891N100	4"	98	100	27	6.9	4	0.086	10	200
SIRN892N150	6"	148	150	27	6.9	4	0.124	10	160

FINISH AVAILABLE - EB, SATIN, MIRROR POLISHED

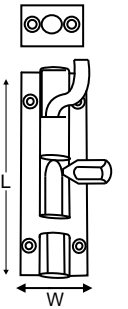

STAINLESS STEEL BARREL BOLT (LIGHT)



ITEM CODE	SIZE	SHOOT LENGTH	LENGTH	WIDTH	SHOOT DIA.	SCREW NO.	WT/PCS	Pcs In Inner	Pcs In Outer
SIRN0887038	1.5"	40	40	27	6.9	4	0.042	10	400
SIRN0888050	2"	50	50	27	6.9	4	0.047	10	400
SIRN0889065	2.5"	65	65	27	6.9	4	0.056	10	340
SIRN0890075	3"	75	75	27	6.9	4	0.066	10	300
SIRN0891100	4"	100	100	27	6.9	4	0.086	10	200
SIRN0892150	6"	150	150	27	6.9	4	0.124	10	160

FINISH AVAILABLE - EB, SATIN, MIRROR POLISHED

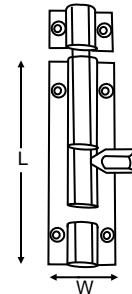

STAINLESS STEEL BARREL BOLT NECKED (HEAVY)



ITEM CODE	SIZE	SHOOT LENGTH	LENGTH	WIDTH	SHOOT DIA.	SCREW NO.	WT/PCS	Pcs In Inner	Pcs In Outer
SIRN0791100	4"	101	100	38	10	6	0.154	10	120
SIRN893N150	6"	148	152	38	10	6	0.218	10	80
SIRN894N200	8"	200	200	38	10	6	0.282	10	60
SIRN895N250	10"	250	250	38	10	6	0.346	10	60

FINISH AVAILABLE - EB, SATIN, MIRROR POLISHED

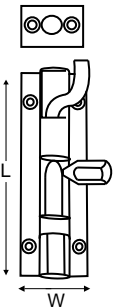

STAINLESS STEEL BARREL BOLT (HEAVY)



ITEM CODE	SIZE	SHOOT LENGTH	LENGTH	WIDTH	SHOOT DIA.	SCREW NO.	WT/PCS	Pcs In Inner	Pcs In Outer
SIRN0891100	4"	98	100	38	10.8	6	0.154	10	120
SIRN0893150	6"	148	152	38	10.8	6	0.218	10	80
SIRN0894200	8"	198	200	38	10.8	6	0.282	10	60
SIRN0895250	10"	248	250	38	10.8	6	0.346	10	60

FINISH AVAILABLE - EB, SATIN, MIRROR POLISHED

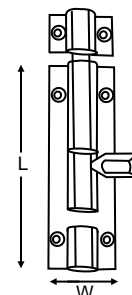

1261SS : STAINLESS STEEL CABIN HOOK



ITEM CODE	LENGTH	Rod Dia	THICKNESS	Screw No.	WT/PCS	Pcs In Inner	Pcs In Outer
SIRN1261065	65	5.6	1.7	6	0.023	20	400
SIRN1261075	75	5.6	1.7	6	0.025	20	400
SIRN1261100	100	5.6	1.7	6	0.043	20	400
SIRN1261125	125	5.6	1.7	6	0.047	20	300
SIRN1261150	150	5.6	1.7	6	0.052	20	300
SIRN1261200	200	5.6	1.7	6	0.061	20	300

FINISH AVAILABLE - SATIN, MIRROR

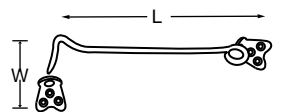

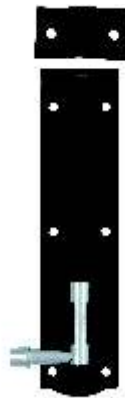
923A : STEEL TOWER BOLT

ITEM CODE	SIZE	SHOOT LENGTH	LENGTH	WIDTH	Thickness	Shoot Dia	Screw No.	WT/PCS	Pcs In Inner	Pcs In Outer
MIRN923A075	3"	76	85	38	0.8	10	6	0.107	10	200
MIRN923A100	4"	101	110	38	0.8	10	6	0.135	10	140
MIRN923A125	5"	126	135	38	0.8	10	6	0.150	10	100
MIRN923A150	6"	151	160	38	0.8	10	6	0.192	10	80
MIRN923A200	8"	207	210	45	1.0	12	6	0.370	10	50
MIRN923A250	10"	257	260	45	1.0	12	6	0.449	10	40
MIRN923A300	12"	303	310	45	1.0	12	6	0.531	10	30

FINISH AVAILABLE - EXB, TEXTURE BLK, EXW, ZP, DUROSIL, EVERBLACK, HSG

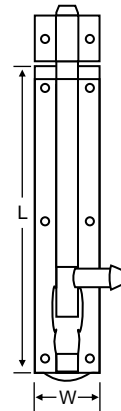
923N : STEEL NECKED TOWER BOLT

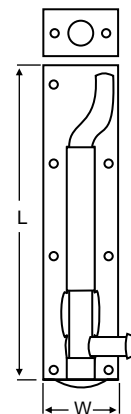

ITEM CODE	SIZE	SHOOT LENGTH	LENGTH	WIDTH	SHOOT DIA.	SCREW NO.	WT/PCS	Pcs In Inner	Pcs In Outer
MIRN923N100	4"	106	110	38	10	6	0.135	10	140
MIRN923N150	6"	150	160	38	10	6	0.195	10	100
MIRN923N200	8"	203	210	45	12	6	0.420	10	50
MIRN923N250	10"	255	260	45	12	6	0.467	10	40

FINISH AVAILABLE - EXB, TEXTURE BLK, EXW, ZP, DUROSIL, EVERBLACK, HSG

925 : STEEL HIGH DOME 13MM TOWER BOLT

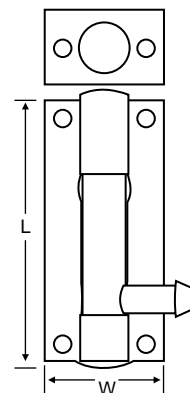
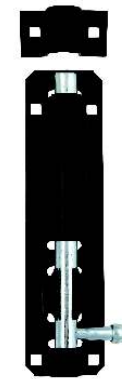

ITEM CODE	SIZE	SHOOT LENGTH	LENGTH	SCREW NO	WT/PCS	Pcs In Inner	Pcs In Outer
MIRN0925075	3"	75	75	6	0.148	10	150
MIRN0925100	4"	100	100	6	0.190	10	120
MIRN0925150	6"	150	150	6	0.276	10	80

FINISH AVAILABLE - EXB, TEXTURE BLK, EXW, ZP, DUROSIL, EVERBLACK, HSG

923SA : BARREL BOLT

ITEM CODE	SIZE	SHOOT LENGTH	LENGTH	WIDTH	THICKNESS	BOLT	WT/PCS	Pcs In Inner	Pcs In Outer
MIRN923SA100	4"	102	117	43	1.6	M5	0.183	10	100
MIRN923SA150	6"	149	167	43	1.6	M5	0.264	10	80
MIRN923SA200	8"	203	217	43	1.6	M5	0.375	10	60
MIRN923SA250	10"	252	267	43	1.6	M5	0.426	10	40

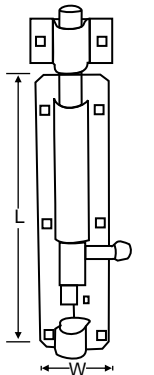
FINISH AVAILABLE - EXB, TEXTURE BLK, EXW, ZP, DUROSIL, EVERBLACK, HSG

923H : STEEL SECTIONAL TOWER BOLT

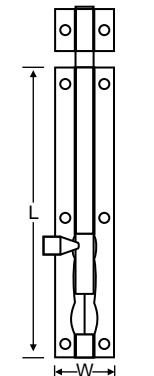

ITEM CODE	SIZE	SHOOT LENGTH	LENGTH	WIDTH	SHOOT DIA	SCREW NO	WT/PCS	Pcs In Inner	Pcs In Outer
MIRN923H075	3"	73	75	33	10	6	0.135	10	200
MIRN923H100	4"	98	100	33	10	6	0.165	10	150
MIRN923H125	5"	123	125	33	10	6	0.210	10	100
MIRN923H150	6"	148	150	33	10	6	0.240	10	80
MIRN923H150	6"	148	150	38	12	6	0.280	10	50
MIRN923H200	8"	200	200	33	10	6	0.420	10	40
MIRN923H200	8"	200	200	38	12	6	0.446	10	40

FINISH AVAILABLE - EXB, TEXTURE BLK, EXW, ZP, DUROSIL, EVERBLACK, HSG

1258 : BARREL BOLT

ITEM CODE	SIZE	SHOOT LENGTH	Section Length	Section Width	Section Thickness	SCREW NO.	SHOOT DIA	WT/PCS	Pcs In Inner	Pcs In Outer
MIRN1258038	1.5"	38	35	39.5	1.2	7	7.8	0.050	20	400
MIRN1258050	2"	50	45	39.5	1.2	7	7.8	0.060	20	300
MIRN1258050	2"	50	55	39.5	1.2	7	7.8	0.070	10	200
MIRN1258100	4"	100	77	39.5	1.2	7	7.8	0.090	10	200

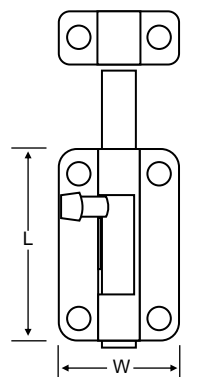
FINISH AVAILABLE - EXB, TEXTURE BLK, EXW, ZP, DUROSIL, EVERBLACK, HSG



1258H : HEAVY BARREL BOLT



ITEM CODE	SIZE	SHOOT LENGTH	LENGTH	WIDTH	THICKNESS	SCREW NO.	SHOOT DIA	WT/PCS	Pcs In Inner	Pcs In Outer
MIRN1258075	3"	75	83	42	1.6	7	10	0.150	10	100
MIRN1258100	4"	100	114	42	1.6	7	10	0.200	10	100

FINISH AVAILABLE - EXB, TEXTURE BLK, EXW, ZP, DUROSIL, EVERBLACK, HSG

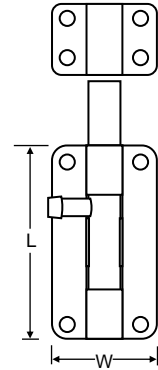

SPARES : KEEPS FOR BOLTS

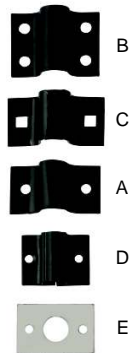

SPARES FOR	LENGTH	WIDTH	THICKNESS	SCREW NO.	WT/PCS	Pcs In Inner	Pcs In Outer
923A	45	25	1.0	6	0.011	50	1000
923A	49	34	1.3	8	0.019	20	500
923SA	47	25	1.8	M5	0.019	50	500
923H	33	25	1.0	6	0.012	50	1000
923H	45	25	2.0	6	0.015	50	800

FINISH AVAILABLE - EXB, TEXTURE BLK, EXW, ZP, DUROSIL, EVERBLACK, HSG

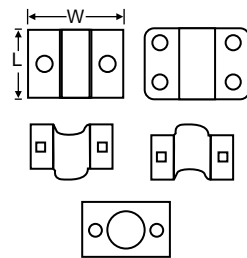

1A : STEEL HEAVY PADBOLT, BRENTON PATTERN



ITEM CODE	SIZE	SHOOT LENGTH	LENGTH	WIDTH	THICKNESS	SCREW NO.	SHOOT DIA	WT/PCS	Pcs In Inner	Pcs In Outer
MIRN001A150	6"	151	155	57	1.9	6	16	0.533	5	40
MIRN001A200	8"	201	205	57	1.9	6	16	0.654	5	35
MIRN001A250	10"	251	254	57	1.9	6	16	0.772	5	25
MIRN001A300	12"	301	305	57	1.9	6	16	0.907	5	20

FINISH AVAILABLE - EXB, TEXTURE BLK, EXW, ZP, DUROSIL, EVERBLACK, HSG

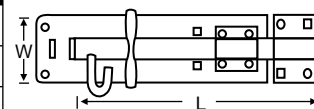

2A : STEEL MEDIUM PADBOLT, BRENTON PATTERN



ITEM CODE	SIZE	SHOOT LENGTH	LENGTH	WIDTH	THICKNESS	SCREW NO.	SHOOT DIA	WT/PCS	Pcs In Inner	Pcs In Outer
MIRN002A100	4"	101	101	45	1.5	6	12	0.242	5	80
MIRN002A150	6"	152	152	45	1.5	6	12	0.305	5	60
MIRN002A200	8"	202	202	45	1.5	6	12	0.385	5	50
MIRN002A250	10"	252	252	45	1.5	6	12	0.452	5	40
MIRN002A300	12"	302	302	45	1.5	6	12	0.530	5	35

FINISH AVAILABLE - EXB, TEXTURE BLK, EXW, ZP, DUROSIL, EVERBLACK, HSG

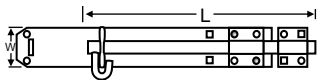

4A : STEEL OVAL PAD BOLT



ITEM CODE	SIZE	SHOOT LENGTH	LENGTH	WIDTH	THICKNESS	BOLT	SHOOT DIA	WT/PCS	Pcs In Inner	Pcs In Outer
MIRN004A100	4"	115	102	54	2.0	M6	12	0.280	10	80

FINISH AVAILABLE - EXB, TEXTURE BLK, EXW, ZP, DUROSIL, EVERBLACK, HSG

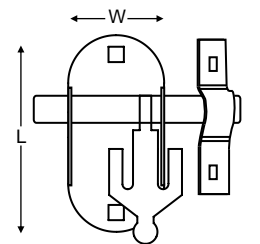

5A : DOOR BOLT FOR PADLOCK



ITEM CODE	SIZE	SHOOT LENGTH	LENGTH	WIDTH	THICKNESS	SCREW NO.	WT/PCS	Pcs In Inner	Pcs In Outer
MIRN005A100	4"	94	101	43	2.2	6	0.130	10	120
MIRN005A120	5"	114	121	45	2.1	6	0.160	10	100
MIRN005A160	6"	144	160	53	2.2	6	0.310	5	60

FINISH AVAILABLE - EXB, TEXTURE BLK, EXW, ZP, DUROSIL, EVERBLACK, HSG

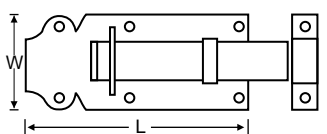

6A: SLIMLINE PADBOLT



ITEM CODE	SIZE	SHOOT LENGTH	LENGTH	WIDTH	THICKNESS	Screw No.	WT/PAIR	Pcs In Inner	Pcs In Outer
MIRN006A100	4"	112	112	32	2.0	6	0.112	10	120
MIRN006A150	6"	144	145	46	2.0	8	0.282	5	60

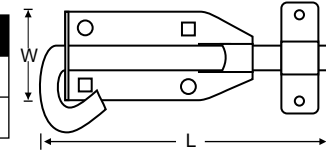

FINISH AVAILABLE - EXB, TEXTURE BLK, EXW, ZP, DUROSIL, EVERBLACK, HSG

2ASA : MEDIUM PADBOLT



ITEM CODE	SIZE	SHOOT LENGTH	LENGTH	WIDTH	THICKNESS	BOLT	SHOOT DIA	WT/PCS	Pcs In Inner	Pcs In Outer
MIRN001A150	4"	117	149	52	1.6	M6	12	0.230	5	40
MIRN001A200	6"	167	200	52	1.6	M6	12	0.317	5	35
MIRN001A250	8"	217	250	52	1.6	M6	12	0.404	5	25
MIRN001A300	10"	267	300	52	1.6	M6	12	0.491	5	20

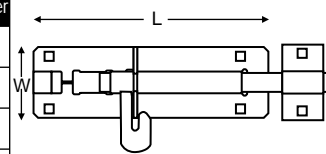

FINISH AVAILABLE - EXB, TEXTURE BLK, EXW, ZP, DUROSIL, EVERBLACK, HSG

4ASA : STEEL OVAL PADBOLT



ITEM CODE	SIZE	SHOOT LENGTH	LENGTH	WIDTH	THICKNESS	SHOOT DIA.	BOLT	WT/PCS	Pcs In Inner	Pcs In Outer
MIRN4ASA100	4.5"	118	75	55	2	114x11.5	M6	0.243	10	80

FINISH AVAILABLE - EXB, TEXTURE BLK, EXW, ZP, DUROSIL, EVERBLACK, HSG

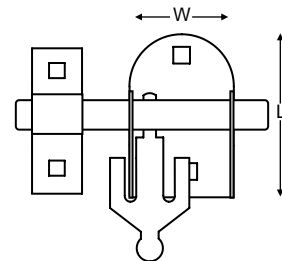

SPARES : KEEPS FOR PADBOLT



NAME	LENGTH	WIDTH	THICKNESS	BOLT	WT/PCS	Pcs In Inner	Pcs In Outer
1A	58	38	2.2	M6	0.057	50	800
2A	50	35	1.1	M6	0.017	50	800
2ASA	58	26	1.6	M6	0.024	50	500
4A, 4ASA	83	23	2.2	M6	0.044	25	400
6A	63	21	1.9	M6	0.024	50	500

FINISH AVAILABLE - EXB, TEXTURE BLK, EXW, ZP, DUROSIL, EVERBLACK, HSG

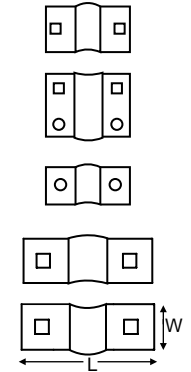

1257 : STEEL SLIDING ACTION BOLT (DOUBLE LOCKING)



ITEM CODE	SIZE	SHOOT LENGTH	LENGTH	WIDTH	THICKNESS	Shoot Dia	Bolt	WT/PCS	Pcs In Inner	Pcs In Outer
MIRN1257100	4"	178	101	57	2.4	9.0	M6	0.250	10	80

FINISH AVAILABLE - EXB, TEXTURE BLK, EXW, ZP, DUROSIL, EVERBLACK, HSG

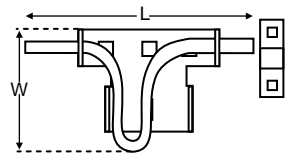

60BHB : STEEL BOW HANDLE BOLT



ITEM CODE	SIZE	LENGTH	WIDTH	THICKNESS	Shoot Square	SCREW No.	WT/Pcs	Pcs In Inner	Pcs In Outer
MIRN60BH300	12"	305	50	2.0	16	10	0.864	2	20
MIRN60BH375	15"	380	50	2.0	16	10	0.927	2	20
MIRN60BH450	18"	458	50	2.0	16	10	1.081	2	16
MIRN60BH600	24"	610	50	2.0	16	10	1.215	2	12
MIRN60BH750	30"	762	50	2.0	16	10	1.349	2	12
MIRN60BH900	36"	915	50	2.0	16	10	1.483	2	12

FINISH AVAILABLE - EXB, TEXTURE BLK, EXW, ZP, DUROSIL, EVERBLACK, HSG

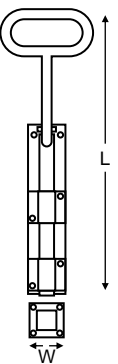

60MTB : STEEL MONKEY TAIL BOLT



ITEM CODE	SIZE	LENGTH	SHOOT SQUARE	THICKNESS	Screw No.	WT/PCS	Pcs In Inner	Pcs In Outer
MIRN60MT300	12"	320	16	2.0	10	0.782	2	24
MIRN60MT375	15"	385	16	2.0	10	0.835	2	22
MIRN60MT450	18"	458	16	2.0	10	0.977	2	20
MIRN60MT600	24"	605	16	2.0	10	1.111	2	12
MIRN60MT750	30"	765	16	2.0	10	1.242	2	12
MIRN60MT900	36"	916	16	2.0	10	1.369	2	10

FINISH AVAILABLE - EXB, TEXTURE BLK, EXW, ZP, DUROSIL, EVERBLACK, HSG

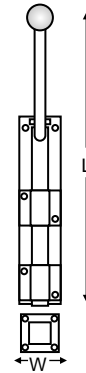

66 : STEEL CHAIN BOLT REVERSIBLE SPRING LOADED SHOOT



ITEM CODE	SIZE	SHOOT LENGTH	LENGTH	SHOOT SQUARE	CHAIN LENGTH	SCREW NO.	WT/PCS	Pcs In Inner	Pcs In Outer
MSCF0066210	8"	206	189	16	18"	10	0.585	5	30

FINISH AVAILABLE - EXB, TEXTURE BLK, EXW, ZP, DUROSIL, EVERBLACK, HSG

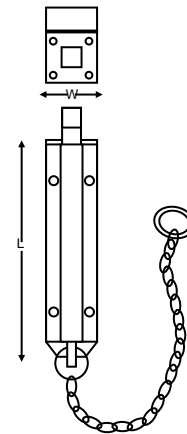

68 : STEEL FOOTBOLT



ITEM CODE	SIZE	SHOOT LENGTH	LENGTH	SHOOT SQUARE	WIDTH	THICKNESS	SCREW NO.	WT/PCS	Pcs In Inner	Pcs In Outer
MIRN0068175	8"	205	186	16	50	2.0	10	0.850	5	25

FINISH AVAILABLE - EXB, TEXTURE BLK, EXW, ZP, DUROSIL, EVERBLACK, HSG

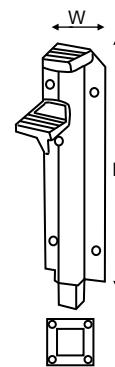

482-83-84-85 : ACCESSORIES FOR BOLTS (TO SUIT 16MM BOLTS)



ITEM CODE	LENGTH	WIDTH	THICKNESS	SCREW NO.	WT/PCS	Pcs In Inner	Pcs In Outer
MIRN0482016	45	48	5.5	8	0.207	50	500
MIRN0483016	50	50	2.0	8	0.033	50	500
MIRN0484016	64	37	1.2	8	0.029	50	500
MIRN0485016	69	50	3.0	8	0.082	50	500

FINISH AVAILABLE - EXB, TEXTURE BLK, EXW, ZP, DUROSIL, EVERBLACK, HSG

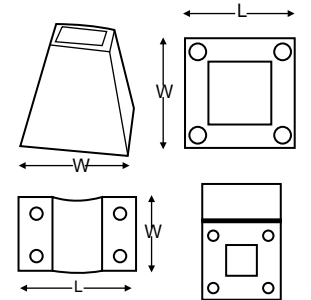

1259 : DOOR BOLT



ITEM CODE	SIZE	Section Length	Section Width	Section Thickness	SHOOT DIA	Screw No.	WT/Pcs	Pcs In Inner	Pcs In Outer
MIRN1259150	6"	155	25	2.0	8.0	7	0.170	10	100
MIRN1259200	8"	200	32	2.0	12.5	7	0.418	10	30
MIRN1259250	10"	250	32	2.0	12.5	7	0.470	10	40
MIRN1259300	12"	300	32	2.0	12.5	7	0.586	10	30

FINISH AVAILABLE - EXB, TEXTURE BLK, EXW, ZP, DUROSIL, EVERBLACK, HSG

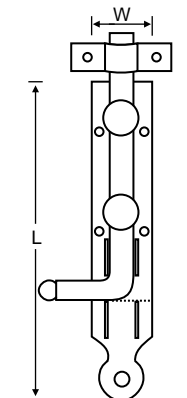

1260L : STEEL LIGHT GARAGE DOOR BOLT WITH RECEIVER PLATE



ITEM CODE	SIZE	LENGTH	Bolt Dia	THICKNESS	SCREW NO.	WT/Pcs	Pcs In Inner	Pcs In Outer
MIRN1260300	12"	310	16	3.0	8	1.003	2	20
MIRN1260375	15"	390	16	3.0	8	1.126	2	20
MIRN1260450	18"	465	16	3.0	8	1.250	2	16
MIRN1260600	24"	617	16	3.0	8	1.580	2	16
MIRN1260750	30"	770	16	3.0	10	1.825	2	12
MIRN1260900	36"	922	16	3.0	10	2.065	2	8

FINISH AVAILABLE - EXB, TEXTURE BLK, EXW, ZP, DUROSIL, EVERBLACK, HSG

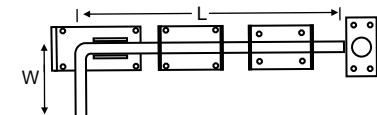

1260H : STEEL HEAVY GARAGE DOOR BOLT WITH RECEIVER PLATE



ITEM CODE	SIZE	LENGTH	Bolt Dia	THICKNESS	SCREW No.	WT/Pcs	Pcs In Inner	Pcs In Outer
MIRN1160300	12"	310	16	4.0	8	1.602	2	20
MIRN1160450	18"	465	16	4.0	8	1.847	2	16
MIRN1160600	24"	617	16	4.0	8	2.085	2	12

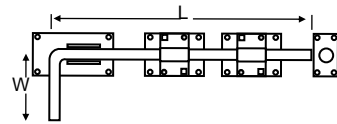

FINISH AVAILABLE - EXB, TEXTURE BLK, EXW, ZP, DUROSIL, EVERBLACK, HSG

1260HLK : STEEL LOCKING GARAGE DOOR BOLT



ITEM CODE	SIZE	LENGTH	WIDTH	THICKNESS	SCREW NO.	WT/PCS	Pcs In Inner	Pcs In Outer
MIRN9971450	18"	455	140	4.0	8 & 12	1.612	2	2

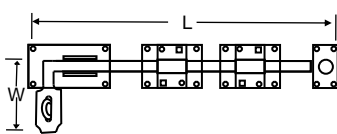

FINISH AVAILABLE - EXB, TEXTURE BLK, EXW, ZP, DUROSIL, EVERBLACK, HSG

597 : STEEL CROSS DOOR BOLT



ITEM CODE	SIZE	LENGTH	Width	Section Thickness	SCREW NO.	SHOOT DIA	WT/Pcs	Pcs In Inner	Pcs In Outer
MIRN0597300	12"	316	64	4.0	8	16	1.936	2	8
MIRN0597450	18"	465	64	4.0	8	16	2.640	2	8
MIRN0597600	24"	616	64	4.0	8	16	3.000	2	8

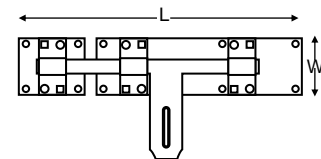

FINISH AVAILABLE - EXB, TEXTURE BLK, EXW, ZP, DUROSIL, EVERBLACK, HSG

6553 : FIELD GATE SHOOT BOLT



ITEM CODE	SIZE	LENGTH	WIDTH	THICKNESS	SCREW NO.	WT/PCS	Pcs In Inner	Pcs In Outer
MGFI16550350	14"	353	125	6.0	10	1.259	5	15

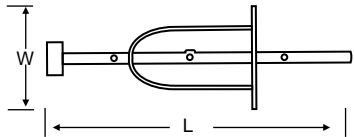

FINISH AVAILABLE - EXB, TEXTURE BLK, EXW, ZP, DUROSIL, EVERBLACK, HSG

213 : CANE BOLT



ITEM CODE	SIZE	LENGTH	WIDTH	SHOOT DIA	SCREW NO.	WT/PCS	Pcs In Inner	Pcs In Outer
MGFI0213300	12"	306	75	12.0	10	0.494	2	2

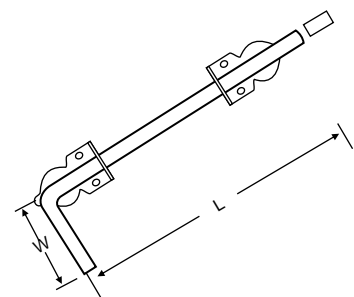

FINISH AVAILABLE - EXB, TEXTURE BLK, EXW, ZP, DUROSIL, EVERBLACK, HSG

7A : AUTO LOCK PIG BOLT

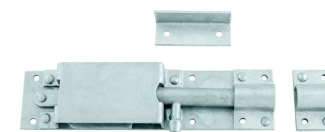

ITEM CODE	SIZE	LENGTH	WIDTH	THICKNESS	SHOOT DIA	WT/PCS	SCREW No.	Pcs In Inner	Pcs In Outer
MGFI007A150	8"	215	50	2.1	14.0	0.668	8	5	20

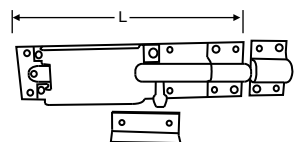

FINISH AVAILABLE - EXB, TEXTURE BLK, EXW, ZP, DUROSIL, EVERBLACK, HSG

1836 : SPRING LOADED ANIMAL BOLT



ITEM CODE	SIZE	LENGTH	WIDTH	THICKNESS	SCREW NO.	SHOOT DIA.	WT/PCS	PCS IN INNER	PCS IN OUTER
MGF11836010	3/8"	143	40	3.0	10	10	0.330	5	50
MGF11836012	1/2"	225	40	4.0	10	12	0.572	5	30
MGF11836016	5/8"	242	50	5.0	10	16	1.042	5	15

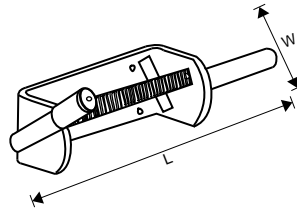

FINISH AVAILABLE - EXB, TEXTURE BLK, EXW, ZP, DUROSIL, EVERBLACK, HSG

1835 : SPRING LOADED ANIMAL BOLT C/W STAPLE



ITEM CODE	SIZE	LENGTH	WIDTH	THICKNESS	SCREW NO.	SHOOT DIA.	WT/PCS	PCS IN INNER	PCS IN OUTER
MGF11835010	3/8"	143	40	3.0	10	10	0.486	5	50
MGF11835012	1/2"	225	40	4.0	10	12	0.728	5	30
MGF11835016	5/8"	242	50	5.0	10	16	1.239	5	15

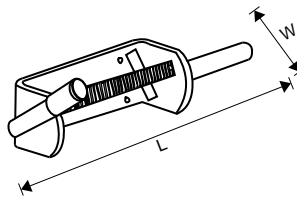

FINISH AVAILABLE - EXB, TEXTURE BLK, EXW, ZP, DUROSIL, EVERBLACK, HSG

1819 : AUTOMATIC GATE CATCH STEEL CASE & PEG



ITEM CODE	SIZE	LENGTH	WIDTH	THICKNESS	Screw No.	Peg Dia Length	WT/PCS	PCS In Inner	PCS In Outer
MGF11819050	2"	51	49	1.4	6	8.5x112	0.148	10	140

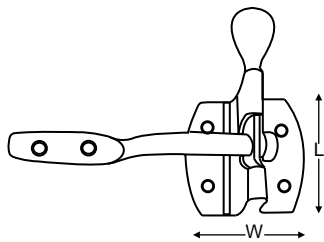

FINISH AVAILABLE - EXB, TEXTURE BLK, EXW, ZP, DUROSIL, EVERBLACK, HSG

1822 : HEAVY AUTOMATIC GATE CATCH STEEL CASE, MALLEABLE IRON PEG



ITEM CODE	SIZE	LENGTH	WIDTH	THICKNESS	Screw No.	Peg Dia Length	WT/SET	Set In Inner	Set In Outer
MGF11822050	2"	57	56	2.6	6	8x114	0.287	10	60

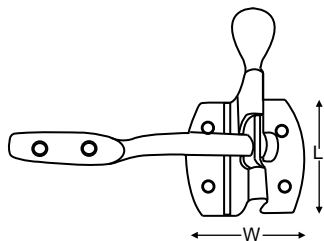

FINISH AVAILABLE - EXB, TEXTURE BLK, EXW, ZP, DUROSIL, EVERBLACK, HSG

PEGS



SUITS FOR	LENGTH	WIDTH	Screw No.	Peg Dia	WT/SET	Set In Inner	Set In Outer
1819	114	15	8	9	0.053	20	200
1822	116	22	12	9	0.115	20	100

FINISH AVAILABLE - EXB, TEXTURE BLK, EXW, ZP, DUROSIL, EVERBLACK, HSG

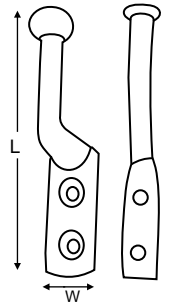

20 : STEEL SUFFOLK LATCH



DPG CODE	ITEM CODE	SIZE	Length	Width	THICKNESS	Screw No.	WT/SET	Set In Inner	Set In Outer
20	MIRN0020175	7"	179	45	1.5	6	0.380	5	50
20	MIRN0020190	7.5"	191	45	1.5	6	0.385	5	50
20	MIRN0020200	8"	205	45	1.5	6	0.400	5	50
50/4	MIRN0050230	9"	230	45	1.5	6	0.442	5	50

FINISH AVAILABLE - EXB, TEXTURE BLK, EXW, ZP, DUROSIL, EVERBLACK, HSG

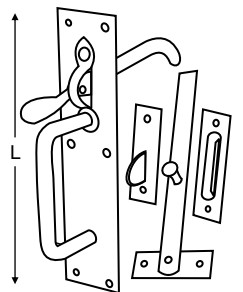

54/4: STEEL SUFFOLK LATCH HEAVY



DPG CODE	ITEM CODE	SIZE	Length	Width	THICKNESS	Screw No.	WT/SET	Set In Inner	Set In Outer
20	MIRN0020175	7"	179	45	2.0	6	0.412	5	50
20	MIRN0020190	7.5"	191	45	2.0	6	0.418	5	50
20	MIRN0020200	8"	205	45	2.0	6	0.436	5	50
50/4	MIRN0050230	9"	230	45	2.0	6	0.483	5	50

FINISH AVAILABLE - EXB, TEXTURE BLK, EXW, ZP, DUROSIL, EVERBLACK, HSG

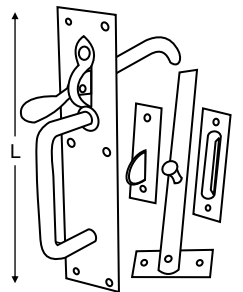

SPARES: FOR 20/2 SUFFOLK LATCH (KEEP, CATCH & T BAR)

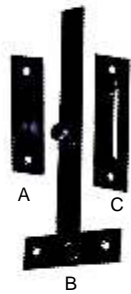

ITEM CODE	LENGTH	WIDTH	THICKNESS	Screw No.	WT/PCS	Pcs In Inner	Pcs In Outer
MMIH020CXXX(A)	74	22	1.5	6	0.025	50	500
MMIH020LXXX(B)	192	65	1.5	6	0.087	20	200
MMIH020KXXX(C)	87	25	1.5	6	0.025	50	500

FINISH AVAILABLE - EXB, TEXTURE BLK, EXW, ZP, DUROSIL, EVERBLACK, HSG

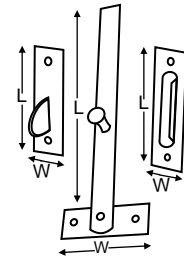

1136 : STEEL GATE LATCH PLAIN RING HANDLE



ITEM CODE	SIZE	LENGTH	WIDTH	THICKNESS	Screw No.	WT/SET	Set In Inner	Set In Outer
MIRN1136127	5"	127	25	4.0	6	0.522	5	40
MIRN1136150	6"	152	25	4.0	6	0.540	5	30
MIRN1136178	7"	178	25	4.0	6	0.562	5	30

FINISH AVAILABLE - EXB, TEXTURE BLK, EXW, ZP, DUROSIL, EVERBLACK, HSG
RING DIA (70MM X 8MM)SPINDLE 8MM X 90MM

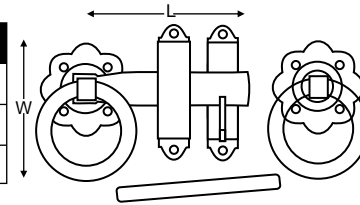

1141 : STEEL GATE LATCH TWISTED RING HANDLE



ITEM CODE	SIZE	LENGTH	WIDTH	THICKNESS	Screw No.	WT/SET	Set In Inner	Set In Outer
MIRN1136127	5"	127	25	4.0	6	0.522	5	40
MIRN1136150	6"	152	25	4.0	6	0.540	5	30
MIRN1136178	7"	178	25	4.0	6	0.562	5	30

FINISH AVAILABLE - EXB, TEXTURE BLK, EXW, ZP, DUROSIL, EVERBLACK, HSG

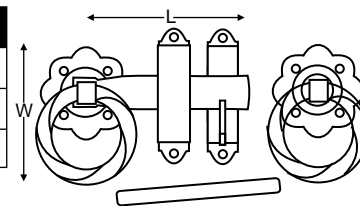

1136BR : STEEL GATE LATCH PLAIN BIG RING HANDLE



ITEM CODE	SIZE	LENGTH	WIDTH	THICKNESS	Screw No.	WT/SET	Set In Inner	Set In Outer
MIRN1137127	5"	127	25	4.0	6	0.565	5	35
MIRN1137150	6"	152	25	4.0	6	0.567	5	30
MIRN1137178	7"	178	25	4.0	6	0.569	5	30

FINISH AVAILABLE - EXB, TEXTURE BLK, EXW, ZP, DUROSIL, EVERBLACK, HSG
Note : Also Available 1136BR Premium
RING DIA (85MM X 8MM)SPINDLE 8MM X 90MM

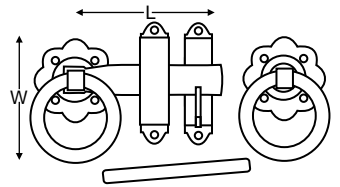

1136EH : EXTRA HEAVY STEEL GATE LATCH PLAIN RING HANDLE



ITEM CODE	SIZE	LENGTH	WIDTH	THICKNESS	Screw No.	WT/SET	Set In Inner	Set In Outer
MIRN1138127	5"	127	25	4.0	6	0.639	5	35
MIRN1138150	6"	152	25	4.0	6	0.642	5	30
MIRN1138178	7"	178	25	4.0	6	0.645	5	30

FINISH AVAILABLE - EXB, TEXTURE BLK, EXW, ZP, DUROSIL, EVERBLACK, HSG
RING DIA (70MM X 8MM)SPINDLE 8MM X 90MM

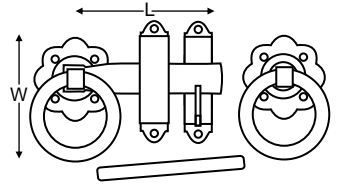

1136A : WENDY HOUSE LATCH



ITEM CODE	SIZE	LENGTH	WIDTH	THICKNESS	SCREW NO.	WT/SET	Set In Inner	Set In Outer
MIRN1135100	4"	101	25	3.2	6	0.411	5	40

FINISH AVAILABLE - EXB, TEXTURE BLK, EXW, ZP, DUROSIL, EVERBLACK, HSG

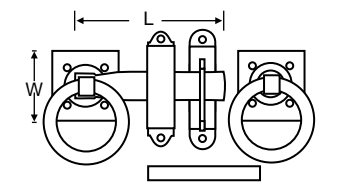

SPARES : RING ONLY

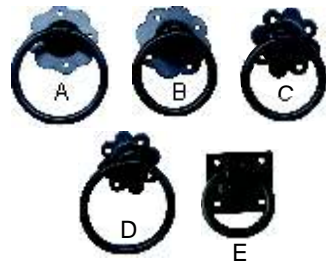

ITEM CODE	Rose Dia	Ring Dia	Ring Wire Dia	Screw No.	WT/PCS	Pcs In Inner	Pcs In Outer
MIRN0137065(A)	66	85	8.0	6	0.170	10	100
MIRN0136065(B)	66	70	8.0	6	0.145	10	100
MIRN0138060(C)	60	70	8.0	6	0.145	10	100
MIRN0139060(D)	60	85	8.0	6	0.171	10	100
MIRN0140050(E)	52	52	8.0	6	0.121	10	100

FINISH AVAILABLE - EXB, TEXTURE BLK, EXW, ZP, DUROSIL, EVERBLACK, HSG
 Note : Also available 141 (Twisted) Ring Handle.

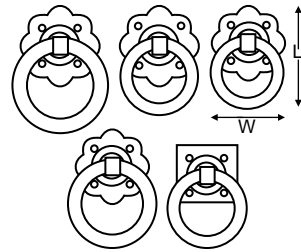

SPARES : FOR RING GATE LATCH (KEEP & CATCH)



ITEM CODE	LENGTH	WIDTH	THICKNESS	SCREW NO.	WT/PCS	Pcs In Inner	Pcs In Outer
MIRN136KXXX(R1)	80	20	1.7	8	0.042	50	400
MIRN136CXXX(R2)	79	20	2.0	8	0.045	50	400

FINISH AVAILABLE - EXB, TEXTURE BLK, EXW, ZP, DUROSIL, EVERBLACK, HSG

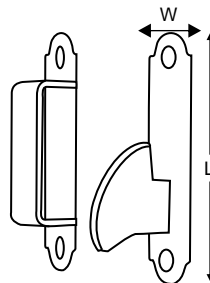

1131 : SURFACE LATCH

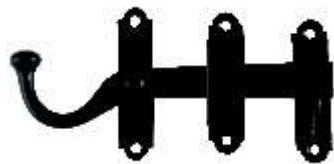

ITEM CODE	SIZE	WIDTH	SCREW No.	WT/PCS	PCS IN INNER	PCS IN OUTER
MIRN1131175	7"	56	8	0.265	10	60

FINISH AVAILABLE - EXB, TEXTURE BLK, EXW, ZP, DUROSIL, EVERBLACK, HSG

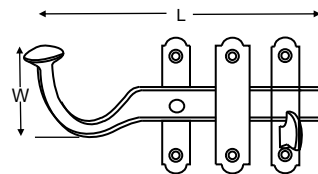

500 : STEEL DOOR SPRING



ITEM CODE	SIZE	LENGTH	WIRE DIA.	THICKNESS	SCREW NO.	WT/PCS	PCS IN INNER	PCS IN OUTER
MGFI0500200	8"	200	4	2.40	8	0.275	5	50
MGFI0500250	10"	250	4	2.40	8	0.337	5	50

FINISH AVAILABLE - EXB, TEXTURE BLK, EXW, ZP, DUROSIL, EVERBLACK, HSG

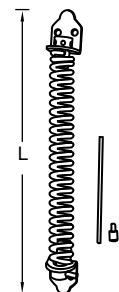

478A: CASEMENT STAY (WITH 1 FLAT CENTRE & 1 FLAT OFFSET PIN)



ITEM CODE	SIZE	LENGTH	WIDTH	THICKNESS	SCREW NO.	WT/PCS	Pcs In Inner	Pcs In Outer
MIRN478A250	10"	250	16	1.0	7	0.120	10	200
MIRN478A300	12"	300	16	1.0	7	0.128	10	200

FINISH AVAILABLE - EXB, EXBR, EXW, ZP, DUROSIL, EVERBLACK, HSG

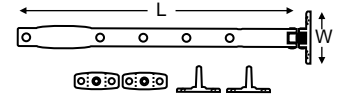

478B: CASEMENT STAY (WITH 9° CENTRE & 9° OFFSET PIN) (EJMA)



ITEM CODE	SIZE	LENGTH	WIDTH	THICKNESS	SCREW NO.	WT/PCS	Pcs In Inner	Pcs In Outer
MIRN478B250	10"	250	16	1.0	8	0.120	10	200
MIRN478B300	12"	300	16	1.0	8	0.128	10	200

FINISH AVAILABLE - EXB, EXBR, EXW, ZP, DUROSIL, EVERBLACK, HSG

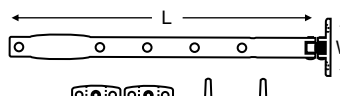

478C: CASEMENT STAY (WITH 2 NOS. 5/16" PINS)



ITEM CODE	SIZE	LENGTH	WIDTH	THICKNESS	SCREW NO.	WT/PCS	Pcs In Inner	Pcs In Outer
MIRN478C250	10"	250	16	1.0	8	0.120	10	200
MIRN478C300	12"	300	16	1.0	8	0.132	10	200

FINISH AVAILABLE - EXB, EXBR, EXW, ZP, DUROSIL, EVERBLACK, HSG

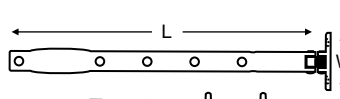

SPARES : PINS FOR CASEMENT STAY (OFFSET & CENTRE)



ITEM CODE	LENGTH	WIDTH	PIN DIA.	SCREW NO.	WT/PCS	Pcs In Inner	Pcs In Outer
OFFSET PIN	40	15	5.2	6	0.011	50	500
CENTRE PIN	40	15	5.2	6	0.011	50	500

FINISH AVAILABLE - EXB, EXBR, EXW, ZP, DUROSIL, EVERBLACK, HSG



GZC2001: CASEMENT FASTENER (WEDGE)



ITEM CODE	LENGTH	WIDTH	SCREW NO.	WT/PCS	Pcs In Inner	Pcs In Outer
ZMIH2001XXX	102	47	7	0.067	10	100

FINISH AVAILABLE - ELECTROBRASS, CHROME, EXW

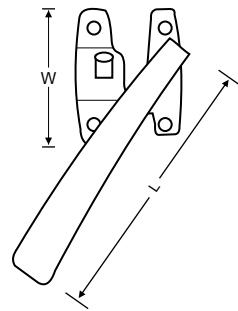

GZC2031: LOCKING CASEMENT FASTENER



ITEM CODE	LENGTH	WIDTH	SCREW NO.	WT/PCS	Pcs In Inner	Pcs In Outer
ZMIH2031XXX	126	62	7	0.155	10	100

FINISH AVAILABLE - ELECTROBRASS, EPOXY SILVER, EXW, EXBR, SATIN NICKEL, CHROME PLATED

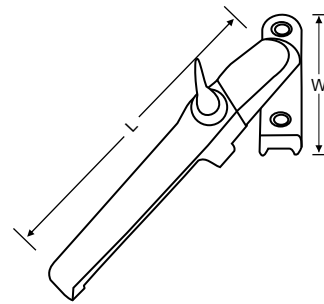

GZC2021: LOCKING CASEMENT STAY



ITEM CODE	LENGTH	WIDTH	SCREW NO.	WT/PCS	Pcs In Inner	Pcs In Outer
ZMIH2021250	260	40	7	0.191	5	60

FINISH AVAILABLE - ELECTROBRASS, EPOXY SILVER, EXW, EXBR, SATIN NICKEL, CHROME PLATED

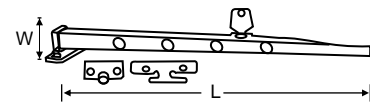

GZC2025: LOCKING CASEMENT STAY (MODERN)



ITEM CODE	LENGTH	WIDTH	SCREW NO.	WT/PCS	Pcs In Inner	Pcs In Outer
ZMIH2025250	252	50	7	0.199	5	60

FINISH AVAILABLE - ELECTROBRASS, EPOXY SILVER, EXW, EXBR, SATIN NICKEL, CHROME PLATED

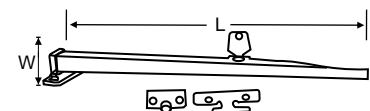

497: TOP FLAP STAY



ITEM CODE	LENGTH	WIDTH	THICKNESS	SCREW NO.	WT/PCS	Pcs In Inner	Pcs In Outer
MMIH0497150	160	44	2.5	6	0.051	10	200

FINISH AVAILABLE - NP WITH WHITE BOSS

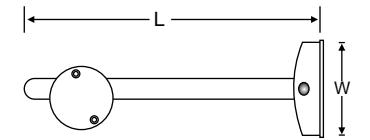

498: SOLID LID STAY



ITEM CODE	LENGTH	WIDTH	THICKNESS	SCREW NO.	WT/PCS	Pcs In Inner	Pcs In Outer
MMIH0498200	160	44	2.5	6	0.050	10	100

FINISH AVAILABLE - NP

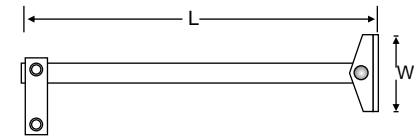

GZC3035: FITCH FASTENER



ITEM CODE	LENGTH	SCREW NO.	WT/PCS	Pcs In Inner	Pcs In Outer
ZMIH3035XXX	65	6	0.059	20	200

FINISH AVAILABLE - ELECTROBRASS, BZP

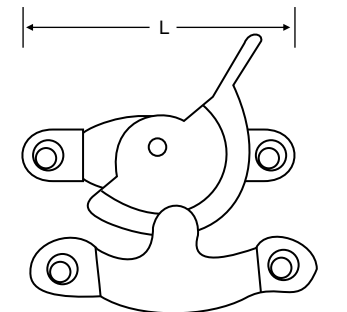

GZC2005: WINDOW FASTENER



ITEM CODE	LENGTH	WIDTH	SCREW NO.	WT/PCS	Pcs In Inner	Pcs In Outer
ZMIH2005XXX	62	45	7	0.065	20	200

FINISH AVAILABLE - ELECTROBRASS, CHROME

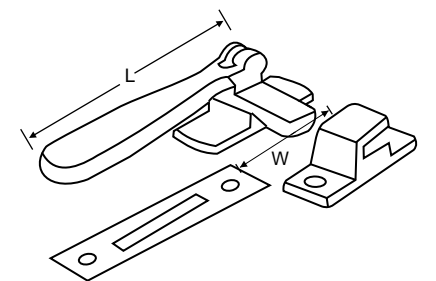

GZC2071 : SASH FASTENER



ITEM CODE	LENGTH	WIDTH	SCREW NO.	WT/PCS	Pcs In Inner	Pcs In Outer
ZMIH2071XXX	62	45	7	0.065	20	200

FINISH AVAILABLE - ELECTROBRASS, BZP, CHROME

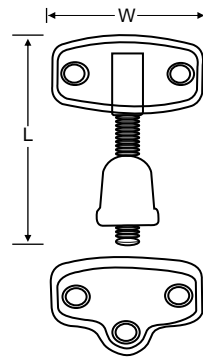

1261 : STEEL WIRE CABIN HOOK



ITEM CODE	SIZE	LENGTH	WIDTH	WIRE DIA	THICKNESS	SCREW NO.	WT/PCS	Pcs In Inner	Pcs In Outer
MIRN1261075	3"	76	40	6.25	2.0	6	0.095	20	240
MIRN1261100	4"	101	40	6.25	2.0	6	0.104	20	200
MIRN1261150	6"	152	40	6.25	2.0	6	0.115	10	200
MIRN1261200	8"	200	40	7.5	2.0	6	0.169	10	120
MIRN1261250	10"	250	40	7.5	2.0	6	0.193	10	100
MIRN1261300	12"	300	40	7.5	2.0	6	0.219	10	100

FINISH AVAILABLE - EXB, TEXTURE BLK, EXW, ZP, DUROSIL, EVERBLACK, HSG

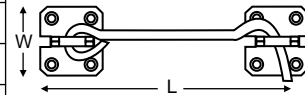

1262 : STEEL EXTRA LONG CABIN HOOK

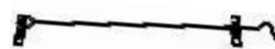

ITEM CODE	SIZE	LENGTH	WIDTH	WIRE DIA	THICKNESS	SCREW NO.	WT/PCS	Pcs In Inner	Pcs In Outer
MIRN1262150	6"	160	12	5.8	1.8	6	0.052	20	300
MIRN1262200	8"	210	12	5.8	1.8	6	0.063	20	240
MIRN1262250	10"	260	12	5.6	1.8	6	0.075	20	300
MIRN1262300	12"	310	12	5.6	1.8	6	0.088	20	240
MIRN1262350	14"	350	12	5.6	1.8	6	0.112	20	200
MIRN1262375	15"	375	12	5.6	1.8	6	0.100	20	160
MIRN1262450	18"	460	12	5.6	1.8	6	0.124	20	140

FINISH AVAILABLE - EXB, TEXTURE BLK, EXW, ZP, DUROSIL, EVERBLACK, HSG

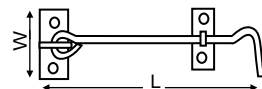

MALLEABLE CABIN HOOK SQUARE CAST PLATE



DPG CODE	ITEM CODE	LENGTH	WIDTH	SCREW NO.	WT/PCS	Pcs In Inner	Pcs In Outer
G0420	CMIH0420100	105	54	8	0.193	10	100
G0421	CMIH0421150	155	54	8	0.202	10	80

FINISH AVAILABLE : EXB, DUROSIL

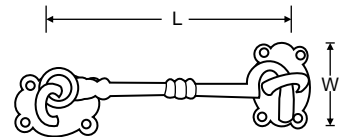

MALLEABLE CABIN HOOK OVAL PLATE



DPG CODE	ITEM CODE	LENGTH	WIDTH	SCREW NO.	WT/PCS.	Pcs In Inner	Pcs In Outer
G2099	CIRN2099075	76	45	8	0.102	10	160
G2100	CIRN2100100	102	45	8	0.126	10	140
G2101	CIRN2101150	152	45	8	0.140	10	120
G2102	CIRN2102200	203	45	8	0.224	10	80
G2103	CIRN2103250	255	45	8	0.236	10	80
G2104	CIRN2104300	305	45	8	0.274	10	60

FINISH AVAILABLE : EXB, DUROSIL, HSG

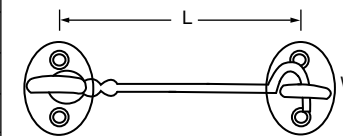

MALLEABLE CABIN HOOK OVAL PLATE WITH RING



DPG CODE	ITEM CODE	LENGTH	WIDTH	SCREW NO.	WT/PCS	Pcs In Inner	Pcs In Outer
G2099A	CIRN3099075	85	45	8	0.104	20	100
G2100A	CIRN3100100	105	45	8	0.120	20	100
G2101A	CIRN3101150	155	45	8	0.142	10	80
G2102A	CIRN3102200	210	45	8	0.205	10	50
G2103A	CIRN3103250	255	45	8	0.226	10	50
G2104A	CIRN3104300	310	45	8	0.330	10	30

FINISH AVAILABLE : EXB, DUROSIL, HSG

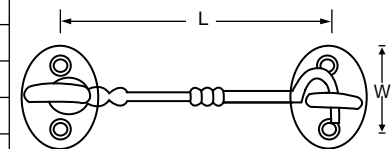

TURN BUTTON



DPG CODE	ITEM CODE	SIZE	LENGTH	WIDTH	SCREW NO.	WT/PAIR	Prs In Inner	Prs In Outer
G1801	CMIH1801038	1.5"	38	11	7	0.011	100	1000
G1802	CMIH1802050	2"	51	13	8	0.020	50	500
G1803	CMIH1803065	2.5"	65	14	8	0.038	50	400

FINISH AVAILABLE : EXB, DUROSIL
SIZE AVAILABLE : 1 1/4" (G1800)

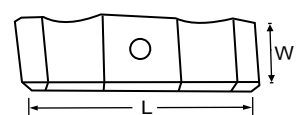

149LW : WIRE HASP AND STAPLE (LIGHT PATTERN)



ITEM CODE	SIZE	LENGTH	WIDTH	THICKNESS	SCREW NO.	WT/PCS	Pcs In Inner	Pcs In Outer
MIRN0150075	3"	76	26	1.0	6	0.016	50	800
MIRN0150100	4"	101	26	1.0	6	0.022	50	500

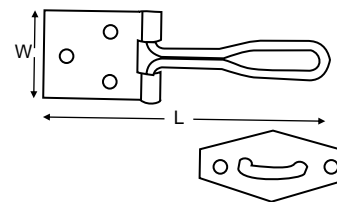

FINISH AVAILABLE - EXB, TEXTURE BLK, EXW, ZP, DUROSIL, EVERBLACK, HSG

149W : WIRE HASP AND STAPLE



ITEM CODE	SIZE	LENGTH	WIDTH	THICKNESS	SCREW NO.	WT/PCS	Pcs In Inner	Pcs In Outer
MIRN149W075	3"	76	26	1.0	6	0.029	50	500
MIRN149W100	4"	101	26	1.0	6	0.047	25	250
MIRN149W125	5"	125	45	2.0	7	0.075	10	200
MIRN149W150	6"	150	45	2.0	7	0.082	10	200

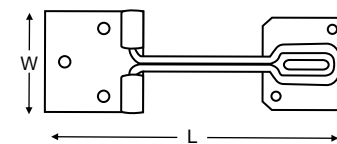

FINISH AVAILABLE - EXB, TEXTURE BLK, EXW, ZP, DUROSIL, EVERBLACK, HSG

617EL : STEEL SAFETY HASP AND STAPLE (EXTRA LIGHT PATTERN)



ITEM CODE	SIZE	LENGTH	WIDTH	THICKNESS	SCREW NO.	WT/PCS	Pcs In Inner	Pcs In Outer
MIRN0618100	4"	100	30	1.0	4	0.038	25	500

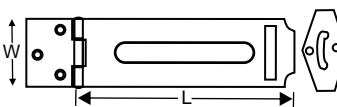

FINISH AVAILABLE - EXB, TEXTURE BLK, EXW, ZP, DUROSIL, EVERBLACK, HSG

617 : STEEL SAFETY HASP AND STAPLE



ITEM CODE	SIZE	LENGTH	WIDTH	THICKNESS	SCREW NO.	WT/PCS	Pcs In Inner	Pcs In Outer
MIRN0617075	3"	76	38	2.0	8	0.090	10	240
MIRN0617090	3.5"	90	38	2.0	8	0.104	10	160
MIRN0617100	4"	114	38	2.0	8	0.136	10	160
MIRN0617150	6"	152	38	2.0	8	0.160	10	120

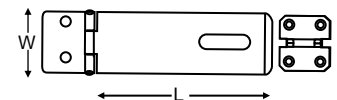

FINISH AVAILABLE - EXB, TEXTURE BLK, EXW, ZP, DUROSIL, EVERBLACK, HSG

149 : STEEL SAFETY HASP AND STAPLE (HEAVY PATTERN)



ITEM CODE	SIZE	LENGTH	WIDTH	THICKNESS	SCREW NO.	WT/PCS	Pcs In Inner	Pcs In Outer
MIRN0149150	6"	158	54	4	12	0.457	5	40
MIRN0149200	8"	203	54	4	12	0.550	5	40
MIRN0149250	10"	253	54	4	12	0.635	5	35
MIRN0149300	12"	305	54	4	12	0.725	5	30



FINISH AVAILABLE - EXB, TEXTURE BLK, EXW, ZP, DUROSIL, EVERBLACK, HSG

* Extra Heavy Pattern

149M : STEEL SAFETY HASP AND STAPLE (MEDIUM WEIGHT LOCKING BAR)



ITEM CODE	SIZE	LENGTH	WIDTH	THICKNESS	SCREW NO.	WT/PCS	Pcs In Inner	Pcs In Outer
MIRN149M200	8"	201	45	3.6	12	0.396	5	40
MIRN149M250	10"	250	54	4.0	12	0.614	5	35

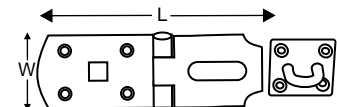

FINISH AVAILABLE - EXB, TEXTURE BLK, EXW, ZP, DUROSIL, EVERBLACK, HSG

147 : SWIVEL LOCKING BAR



ITEM CODE	SIZE	LENGTH	WIDTH	THICKNESS	SCREW NO.	WT/PCS	Pcs In Inner	Pcs In Outer
MIRN0147200	8"	203	54	4.0	12	0.693	5	25
MIRN0147250	10"	251	54	4.0	12	0.780	5	25
MIRN0147300	12"	307	54	4.0	12	0.870	5	20

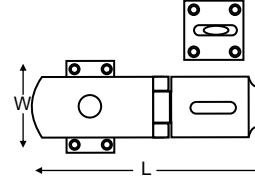

FINISH AVAILABLE - EXB, TEXTURE BLK, EXW, ZP, DUROSIL, EVERBLACK, HSG

146 : VERTICAL HASP AND STAPLE



ITEM CODE	SIZE	LENGTH	WIDTH	THICKNESS	SCREW NO.	WT/PCS	Pcs In Inner	Pcs In Outer
MIRN0146150	6"	150	54	4.6	12	0.651	5	25

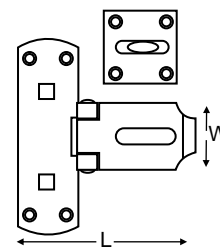

FINISH AVAILABLE - EXB, TEXTURE BLK, EXW, ZP, DUROSIL, EVERBLACK, HSG

GLH001: LOCKING HASP AND STAPLE



ITEM CODE	SIZE	LENGTH	WIDTH	THICKNESS	SCREW NO.	WT/PCS	Pcs In Inner	Pcs In Outer
MSCF0001114	4"	115	32	1.5	6	0.120	10	100

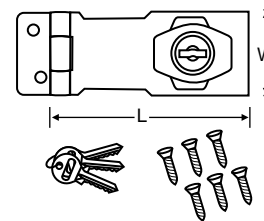

FINISH AVAILABLE - EXB, BZP, DUROSIL, EVERBLACK, CP

151LH / 151RH : PADLOCK PROTECTION BAR (RIGHT HAND & LEFT HAND)



ITEM CODE	SIZE	LENGTH	WIDTH	THICKNESS	BOLT	WT/PCS	Pcs In Inner	Pcs In Outer
MIRN151L185	7"	180	58	2.0	M6	0.563	2	30
MIRN151R185	7"	180	58	2.0	M6	0.563	2	30

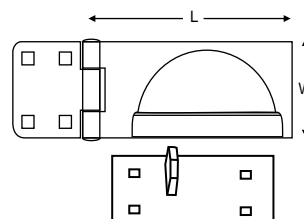

FINISH AVAILABLE - EXB, TEXTURE BLK, EXW, ZP, DUROSIL, EVERBLACK, HSG

1010 : GARAGE DOOR HOLDER SENIOR FOR WIDE LINTELS



ITEM CODE	SIZE	LENGTH	WIDTH	THICKNESS	SCREW NO.	WT/PCS	Pcs In Inner	Pcs In Outer
MGF11010600	24"	620	58	4.0	10	0.911	2	20

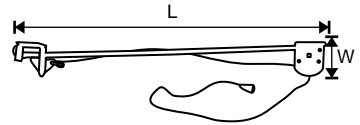

FINISH AVAILABLE - EXB, TEXTURE BLK, EXW, EX BLUE, ZP, DUROSIL, EVERBLACK, HSG

1011: GARAGE DOOR HOLDER FOR NARROW LINTELS



ITEM CODE	SIZE	LENGTH	WIDTH	THICKNESS	SCREW NO.	WT/PCS	Pcs In Inner	Pcs In Outer
MGF11011600	24"	646	58	4.0	10	0.921	2	20

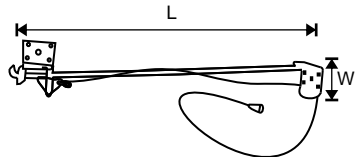

FINISH AVAILABLE - EXB, TEXTURE BLK, EXW, ZP, DUROSIL, EVERBLACK, HSG

1012 : GARAGE DOOR HOLDER JUNIOR FOR WIDE LINTELS



ITEM CODE	SIZE	LENGTH	WIDTH	THICKNESS	SCREW NO.	WT/PCS	Pcs In Inner	Pcs In Outer
MGF11012375	15"	380	58	4.0	10	0.645	2	20

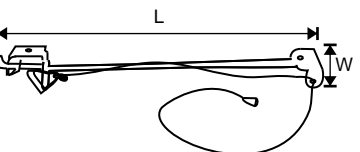

FINISH AVAILABLE - EXB, TEXTURE BLK, EXW, ZP, DUROSIL, EVERBLACK, HSG

SSB001: SHED SECURITY BAR



ITEM CODE	LENGTH	OVAL SIZE	WT/PCS	Pcs In Inner	Pcs In Outer
SSB01080	1080	38x20	1.806	1	10

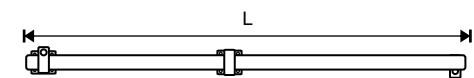

FINISH AVAILABLE - EXB, TEXTURE BLK, EXW, ZP, DUROSIL, EVERBLACK, HSG

236 : HANDRAIL BRACKET



ITEM CODE	SIZE	LENGTH	Top Plate LxW	ROD DIA	SCREW NO.	WT/PCS	Pcs In Inner	Pcs In Outer
MIRN0236063	2.5"	65	61x22	10	8	0.134	10	100
MIRN0236075	3"	77	60x22	10	8	0.145	10	100

FINISH AVAILABLE - EXB, TEXTURE BLK, EXW, ZP, DUROSIL, EVERBLACK, HSG

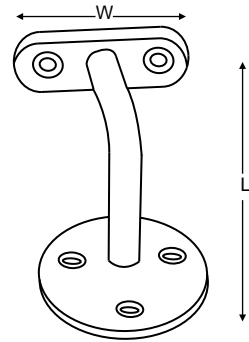

236FB : HANDRAIL BRACKET FIX BENDED (EURO) (FRENCH SPECIFICATION)



ITEM CODE	SIZE	LENGTH	Top Plate LxW	ROD DIA	SCREW NO.	WT/PCS	Pcs In Inner	Pcs In Outer
MIRN0237075	3"	75	70 x18	10	10	0.148	10	100

FINISH AVAILABLE - EXB, TEXTURE BLK, EXW, ZP, DUROSIL, EVERBLACK, HSG

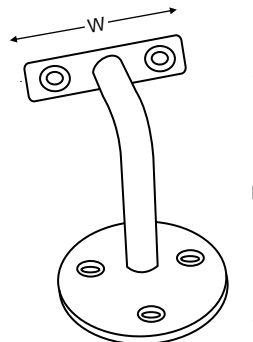

236AB/AS : HANDRAIL BRACKETS ADJUSTABLE BENDED/STRAIGHT (FRENCH SPECIFICATION)



ITEM CODE	SIZE	LENGTH	WIDTH	ROD DIA	SCREW NO.	WT/PCS	Pcs In Inner	Pcs In Outer
MIRN0238050	2.5"	50/70	18	10	10	0.180	10	100
MIRN0239055	3"	55/80	18	10	10	0.200	10	100

FINISH AVAILABLE - EXB, TEXTURE BLK, EXW, ZP, DUROSIL, EVERBLACK, HSG

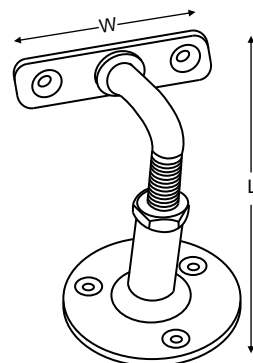

1247 : FLUTED ANGLE BRACKET



ITEM CODE	SIZE	LENGTH	WIDTH	THICKNESS	SCREW NO.	WT/PCS	PCS IN OUTER BOX
MGFI1247075	2"X3"	50X75	20	3.7	8	0.140	20
MGFI1247100	3"X4"	75X100	20	3.7	8	0.150	20
MGFI1247125	4"X5"	100X125	20	3.7	8	0.175	20
MGFI1247150	6"X8"	150X200	25	5.0	8	0.347	20
MGFI1247200	8"X10"	200X250	25	5.0	8	0.427	20
MGFI1247250	10"X12"	250X300	25	5.0	8	0.551	20
MGFI1247300	12"X14"	300X350	25	5.0	8	0.692	20

FINISH AVAILABLE - EXB, TEXTURE BLK, EXW, ZP, DUROSIL, EVERBLACK, HSG

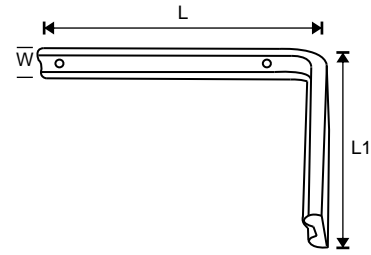

319L : STEEL CORNER BRACES (LIGHT) COUNTER SUNK - INSIDE/OUTSIDE

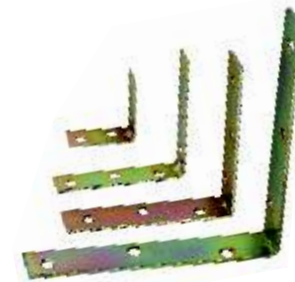

ITEM CODE	SIZE	LENGTH	WIDTH	THICKNESS	Screw No.	WT/PCS	Pcs In Inner	Pcs In Outer
MIRN0319025	1"	25	16	1.6	6	0.009	50	4400
MIRN0319038	1.5"	38	16	1.6	6	0.012	50	1500
MIRN0319050	2"	50	16	1.6	6	0.019	50	1000
MIRN0319065	2.5"	65	19	1.7	6	0.025	50	600
MIRN0319075	3"	75	19	1.7	7	0.030	50	500
MIRN0319100	4"	100	22	2.30	7	0.075	25	250
MIRN0319125	5"	125	22	2.30	7	0.096	25	200
MIRN0319150	6"	150	26	2.5	8	0.145	25	150

FINISH AVAILABLE - EXB, TEXTURE BLK, EXW, ZP, DUROSIL, EVERBLACK, HSG
Note : 320 Inside Countersunk And 321 Outside Countersunk also available.

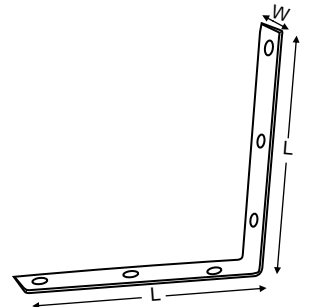

319H : STEEL CORNER BRACES (HEAVY) COUNTER SUNK - INSIDE/OUTSIDE



ITEM CODE	SIZE	LENGTH	WIDTH	THICKNESS	Screw No.	WT/PCS	Pcs In Inner	Pcs In Outer
MIRN0320027	1"	27	16	2.0	6	0.011	50	4400
MIRN0320038	1.5"	39	16	2.0	6	0.015	50	1500
MIRN0320050	2"	52	16	2.0	6	0.021	50	1000
MIRN0320065	2.5"	66	16	2.0	6	0.028	50	600
MIRN0320075	3"	76	16	2.0	6	0.033	50	500
MIRN0320100	4"	101	22	2.5	7	0.082	25	250
MIRN0320125	5"	127	22	2.5	7	0.102	25	200
MIRN0320150	6"	152	25	2.5	7	0.146	25	150

FINISH AVAILABLE - EXB, TEXTURE BLK, EXW, ZP, DUROSIL, EVERBLACK, HSG
Note : 320 Inside Countersunk And 321 Outside Countersunk also available.

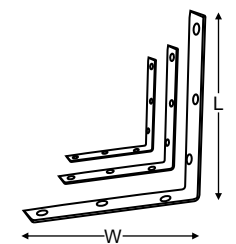

319RC : ROUND CORNER BRACKET



ITEM CODE	SIZE	LENGTH	WIDTH	THICKNESS	SCREW NO.	WT/PCS	Pcs In Inner	Pcs In Outer
MIRN0321019	3/4"	19	19	1.0	8	0.004	1000	5000

FINISH AVAILABLE - EXB, TEXTURE BLK, EXW, ZP, DUROSIL, EVERBLACK, HSG

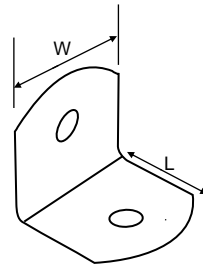

218 : STEEL STRETCHER PLATE (LIGHT)



ITEM CODE	SIZE	LENGTH	WIDTH W1XW2	THICKNESS	Screw No.	WT/PCS	Pcs In Inner	Pcs In Outer
MIRN0315038	1"	28	25x25	1.15	6	0.011	100	1000

FINISH AVAILABLE - EXB, TEXTURE BLK, EXW, ZP, DUROSIL, EVERBLACK, HSG

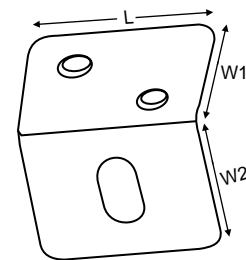

315 : STEEL STRETCHER PLATE

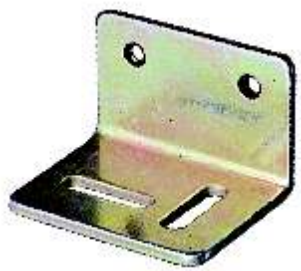

ITEM CODE	SIZE	LENGTH	WIDTH W1XW2	THICKNESS	Screw No.	WT/PCS	Pcs In Inner	Pcs In Outer
MIRN0315038	1.5"	38	25x29	1.8	8	0.025	100	800

FINISH AVAILABLE - EXB, TEXTURE BLK, EXW, ZP, DUROSIL, EVERBLACK, HSG

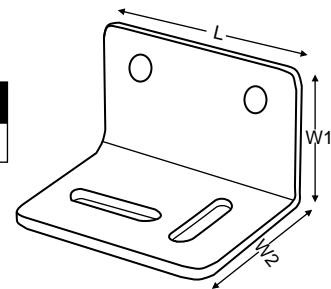

324 : STEEL CORNER PLATE

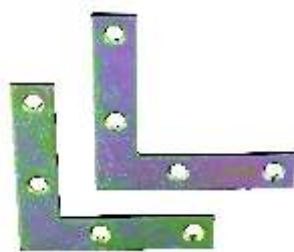

ITEM CODE	SIZE	LENGTH	WIDTH	THICKNESS	Screw No.	WT/PCS	Pcs In Inner	Pcs In Outer
MIRN0324050	2"	50	13	1.5	6	0.014	50	1500
MIRN0324065	2.5"	67	16	1.8	7	0.022	50	1000
MIRN0324075	3"	78	16	1.6	8	0.033	50	600
MIRN0324100	4"	100	16	2.65	8	0.054	25	400
MIRN0324125	5"	125	19	2.65	8	0.091	25	225
MIRN0324150	6"	150	22	2.65	8	0.122	25	150

FINISH AVAILABLE - EXB, TEXTURE BLK, EXW, ZP, DUROSIL, EVERBLACK, HSG

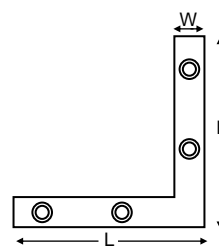

318 : STEEL TEE PLATE



ITEM CODE	SIZE	LENGTH	WIDTH	THICKNESS	SCREW NO.	WT/PCS	Pcs In Inner	Pcs In Outer
MIRN0318075	3"	75	16	2.0	8	0.066	25	800
MIRN0318100	4"	100	19	2.0	8	0.108	25	400

FINISH AVAILABLE - EXB, TEXTURE BLK, EXW, ZP, DUROSIL, EVERBLACK, HSG

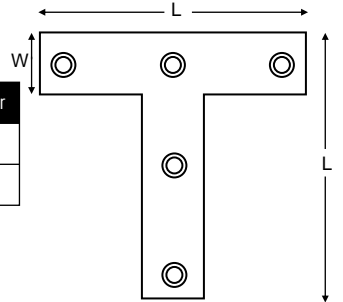

325 : STEEL MENDING PLATE



ITEM CODE	SIZE	LENGTH	WIDTH	THICKNESS	SCREW NO.	WT/PCS	Pcs In Inner	Pcs In Outer
MIRN0325075	3"	76	16	1.85	7	0.022	50	1000
MIRN0325100	4"	100	16	2.0	7	0.029	50	700
MIRN0325125	5"	126	19	2.5	8	0.042	25	450
MIRN0325150	6"	151	19	2.5	8	0.053	25	300

FINISH AVAILABLE - EXB, TEXTURE BLK, EXW, ZP, DUROSIL, EVERBLACK, HSG

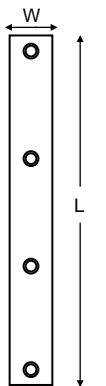

325H : HEAVY STEEL MENDING PLATE



ITEM CODE	SIZE	LENGTH	WIDTH	THICKNESS	SCREW NO.	WT/PCS	Pcs In Inner	Pcs In Outer
MIRN325H075	3"	75	19	2.5	7	0.025	50	800
MIRN325H100	4"	100	25	2.5	8	0.049	50	400
MIRN325H125	5"	125	25	2.5	9	0.057	25	350
MIRN325H150	6"	150	25	2.5	9	0.070	25	300
MIRN325H305	12"	305	29	4.5	12	0.285	10	80

FINISH AVAILABLE - EXB, TEXTURE BLK, EXW, ZP, DUROSIL, EVERBLACK, HSG

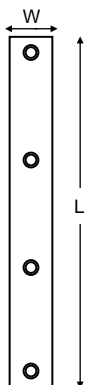

316/317 : STEEL SLOT PLATE (HEAVY) HORIZONTAL/ VERTICAL



ITEM CODE	SIZE	LENGTH	WIDTH	THICKNESS	SCREW NO.	WT/PCS	Pcs In Inner	Pcs In Outer
MIRN0316050	1.5"	50	38	3.0	10	0.040	100	600
MIRN0317050	1.5"	50	38	3.0	10	0.040	100	600

FINISH AVAILABLE - EXB, TEXTURE BLK, EXW, ZP, DUROSIL, EVERBLACK, HSG

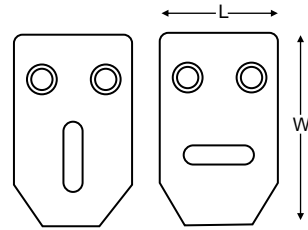

316A/317A : STEEL SLOT PLATE (LIGHT) HORIZONTAL/ VERTICAL



ITEM CODE	SIZE	LENGTH	WIDTH	THICKNESS	SCREW NO.	WT/PCS	Pcs In Inner	Pcs In Outer
MIRN0316A045	1.5"	44	32	2.35	8	0.022	100	600
MIRN0317A045	1.5"	44	32	2.35	8	0.022	100	600

FINISH AVAILABLE - EXB, TEXTURE BLK, EXW, ZP, DUROSIL, EVERBLACK, HSG

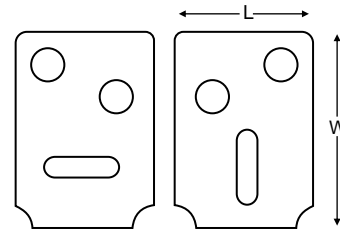

70070 : FLANGE BRACKET



ITEM CODE	SIZE	LENGTH	WIDTH	THICKNESS	SCREW NO.	WT/PCS	Pcs In Inner	Pcs In Outer
MIRN7007083	3.25"	83	83	1	4	0.031	50	500

FINISH AVAILABLE - EXB, TEXTURE BLK, EXW, ZP, DUROSIL, EVERBLACK, HSG

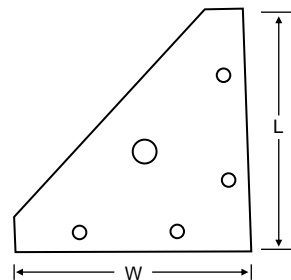

70080 : CORNER BRACKET



ITEM CODE	SIZE	LENGTH	WIDTH	THICKNESS	SCREW NO.	WT/PCS	Pcs In Inner	Pcs In Outer
MIRN7008050	2.5"	64	64	1.0	4	0.034	50	500

FINISH AVAILABLE - EXB, TEXTURE BLK, EXW, ZP, DUROSIL, EVERBLACK, HSG

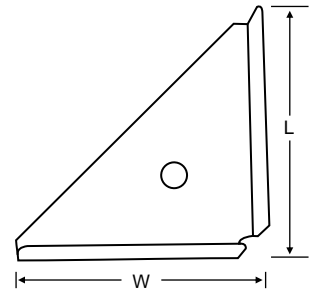

329: Z BRACKET



ITEM CODE	SIZE	LENGTH	WIDTH	THICKNESS	SCREW NO.	WT/PCS	Pcs In Inner	Pcs In Outer
MIRN0329035	2.5"	68	31	1.0	4	0.034	50	1000

FINISH AVAILABLE - EXB, TEXTURE BLK, EXW, ZP, DUROSIL, EVERBLACK, HSG

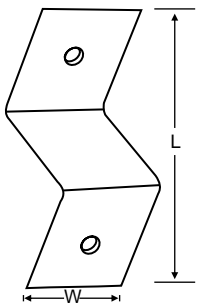

326 : CONNECTING BRACKET



ITEM CODE	SIZE	LENGTH	WIDTH	THICKNESS	SCREW NO.	WT/PCS	Pcs In Inner	Pcs In Outer
MIRN0326050	2.5"	60	18	0.9	4	0.008	100	1000

FINISH AVAILABLE - EXB, TEXTURE BLK, EXW, ZP, DUROSIL, EVERBLACK, HSG

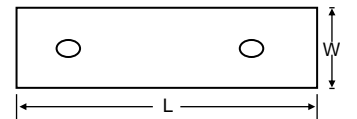

327 : TWISTED BRACKET



ITEM CODE	SIZE	LENGTH	WIDTH	THICKNESS	SCREW NO.	WT/PCS	Pcs In Inner	Pcs In Outer
MIRN0327XXX	2.5"	60	18	0.9	4	0.008	100	1000

FINISH AVAILABLE - EXB, TEXTURE BLK, EXW, ZP, DUROSIL, EVERBLACK, HSG

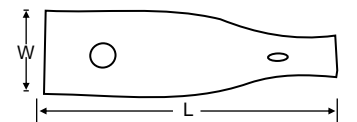

331: RIDGE PLATE



ITEM CODE	SIZE	LENGTH	WIDTH	THICKNESS	SCREW NO.	WT/PCS	Pcs In Inner	Pcs In Outer
MIRN0331038	1.5"	27X26	38	1.4	4	0.034	50	500

FINISH AVAILABLE - EXB, TEXTURE BLK, EXW, ZP, DUROSIL, EVERBLACK, HSG

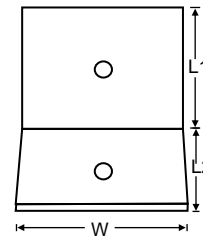

585: MIRROR PLATE PLAIN



ITEM CODE	SIZE	LENGTH	WIDTH	THICKNESS	SCREW NO.	WT/PCS	Pcs In Inner	Pcs In Outer
MIRN5850250	1"	25	27	0.8	4	0.003	100	2000
MIRN5860320	1.25"	32	32	0.8	4	0.005	100	2000
MIRN5860380	1.5"	38	38	0.8	4	0.006	100	2000
MIRN5860500	2"	50	50	0.8	4	0.009	100	2000

FINISH AVAILABLE - EXB, TEXTURE BLK, EXW, ZP, DUROSIL, EVERBLACK, HSG

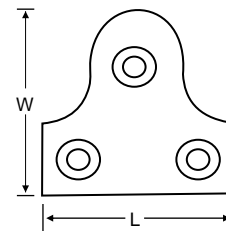

585S: MIRROR PLATE SLOTTED



ITEM CODE	SIZE	LENGTH	WIDTH	THICKNESS	SCREW NO.	WT/PCS	Pcs In Inner	Pcs In Outer
MIRN585S0250	1"	25	27	0.8	4	0.003	100	2000
MIRN586S0320	1.25"	32	32	0.8	4	0.005	100	2000
MIRN586S0380	1.5"	38	38	0.8	4	0.006	100	2000
MIRN586S0500	2"	50	50	0.8	4	0.008	100	2000

FINISH AVAILABLE - EXB, TEXTURE BLK, EXW, ZP, DUROSIL, EVERBLACK, HSG

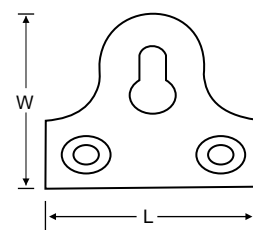

790: QUADRANT STAY - LEFT HANDED & RIGHT HANDED



ITEM CODE	SIZE	LENGTH	WIDTH	THICKNESS	SCREW NO.	WT/SET	Set In Inner	Set In Outer
MMIH0790150	6"	185	65	2.6	10	0.220	5	50

FINISH AVAILABLE - EXB, TEXTURE BLK, EXW, ZP, DUROSIL, EVERBLACK, HSG

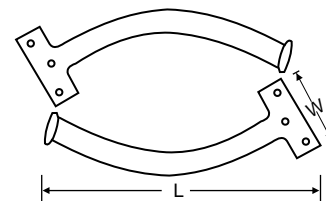

246: STEEL CHEST HANDLE



ITEM CODE	SIZE	LENGTH	WIDTH	THICKNESS	Screw No.	WT/PRS	Prs In Inner	Prs In Outer
MHIN0950100	4"	100	35	1.5	6	0.340	5	50

FINISH AVAILABLE - EXB, TEXTURE BLK, EXW, ZP, DUROSIL, EVERBLACK, HSG

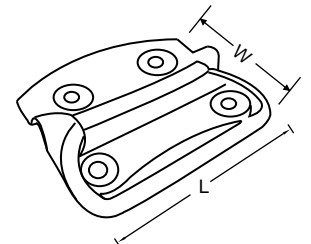

258: STEEL TUBULAR HANDLE



ITEM CODE	SIZE	LENGTH	WIDTH	THICKNESS	Screw No.	WT/PCS	Pcs In Inner	Pcs In Outer
MHND0258150	6"	150	38	1.0	7	0.042	20	200
MHND0258175	7"	175	38	1.0	7	0.058	20	200

FINISH AVAILABLE - EXB, TEXTURE BLK, EXW, ZP, DUROSIL, EVERBLACK, HSG

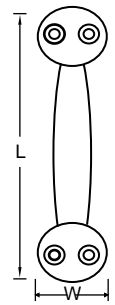

258H: STEEL HEAVY PULL HANDLE



ITEM CODE	SIZE	LENGTH	THICKNESS	Screw No.	WT/Pcs	Pcs In Inner	Pcs In Outer
MHIN0259165	6"	165	2.5	7	0.080	20	300
MHIN0259175	7"	175	2.5	8	0.140	10	150

FINISH AVAILABLE - EXB, TEXTURE BLK, EXW, ZP, DUROSIL, EVERBLACK, HSG

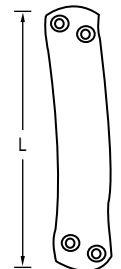

HOT BED HANDLE



DPG CODE	ITEM CODE	SIZE	LENGTH	WIDTH	SCREW NO.	WT/PCS	Pcs In Inner	Pcs In Outer
G1100	CHND1100150	6"	155	15	7	0.066	10	200
G1100A	CHND1112175	7"	185	18	7	0.100	10	200

FINISH AVAILABLE : EXB, EXW, DUROSIL
SIZE AVAILABLE IN 125MM (G1100S) , 200MM (G1100B)

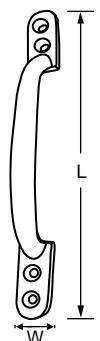

HOT BED HANDLE



DPG CODE	ITEM CODE	SIZE	LENGTH	WIDTH	SCREW NO.	WT/PCS	Pcs In Inner	Pcs In Outer
G1100L	CHND1114100	4"	107	14	7	0.044	20	400
G1100L	CHND1115150	6"	155	14	7	0.052	20	300

FINISH AVAILABLE : EXB, EXW, DUROSIL

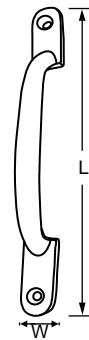

71705 : DOOR STOPPER



ITEM CODE	SIZE	HEIGHT	WIDTH	SCREW NO.	WT/PCS	Pcs In Inner	Pcs In Outer
MIRN7175SML	5"	119	12	6	0.098	10	100
MIRN7176LRG	6"	166	30	7	0.216	5	80

FINISH AVAILABLE - EPOXY SILVER, ELECTRO BRASS & CHROME PLATED

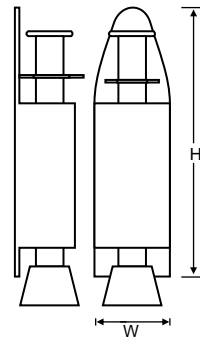

70090 : MINI MOUNT



ITEM CODE	SIZE	LENGTH	WIDTH	THICKNESS	SCREW NO.	WT/PCS	Pcs In Inner	Pcs In Outer
MIRN70090XXX	1.5"	40	16	1.4	4	0.006	100	2000

FINISH AVAILABLE - EXB, TEXTURE BLK, EXW, ZP, DUROSIL, EVERBLACK, HSG

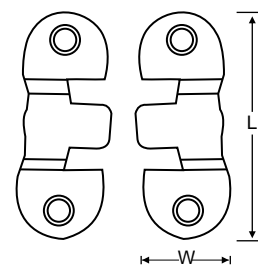

780



401

LARGE PATTERN TABLE BRACE PLATE

TWISTED SUPPORT BRACKET

FINISH AVAILABLE - EXB, TEXTURE BLK, EXW, ZP, DUROSIL, EVERBLACK, HSG

GP039 : SINGLE SCREW PULLEY



ITEM CODE	SIZE	LENGTH	WIDTH	THICKNESS	WHEEL DIA.	WT/PCS	Pcs In Inner	Pcs In Outer
MPUL0039045	1.75"	62	40	2	43	0.074	10	100

FINISH AVAILABLE - EXB, TEXTURE BLK, EXW, ZP, DUROSIL, EVERBLACK, HSG

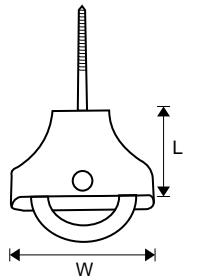

GP042 : DOUBLE SCREW PULLEY



ITEM CODE	SIZE	LENGTH	WIDTH	THICKNESS	WHEEL DIA.	WT/PCS	Pcs In Inner	Pcs In Outer
MPUL0042045	1.75"	68	38	2	43	0.115	10	100

FINISH AVAILABLE - EXB, TEXTURE BLK, EXW, ZP, DUROSIL, EVERBLACK, HSG

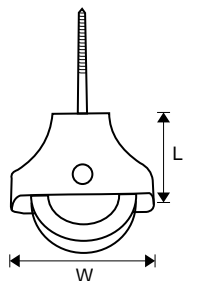

GP260 : SINGLE CLOTHES LINE PULLEY



ITEM CODE	SIZE	LENGTH	WIDTH	THICKNESS	WHEEL DIA.	WT/PCS	Pcs In Inner	Pcs In Outer
MPUL0260032	1.25"	114	32	1.9	30	0.097	10	100

FINISH AVAILABLE - EXB, TEXTURE BLK, EXW, ZP, DUROSIL, EVERBLACK, HSG

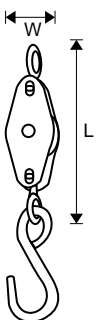

GP260A : SINGLE CLOTHES LINE PULLEY



ITEM CODE	SIZE	LENGTH	WIDTH	THICKNESS	DIA	WT/PCS	Pcs In Inner	Pcs In Outer
MPUL260A038	1.5"	120	38	2.2	35	0.115	10	100

FINISH AVAILABLE - EXB, TEXTURE BLK, EXW, ZP, DUROSIL, EVERBLACK, HSG

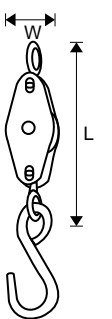

202A : AXLE PULLEY WITH PLATE, NYLON WHEEL FOREND

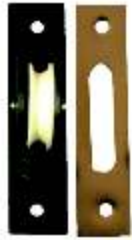

ITEM CODE	SIZE	LENGTH	WIDTH	THICKNESS	WHEEL DIA	WT/PCS	Pcs In Inner	Pcs In Outer
MPUL202A040	1.75"	112	25	3.0	43	0.160	10	100

FINISH AVAILABLE - EXB, TEXTURE BLK, EXW, ZP, DUROSIL, EVERBLACK, HSG
PLATE FINISHES - EB, GP, SNP

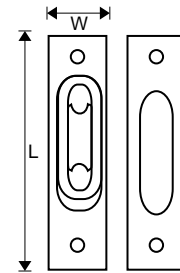

GP202 : AXLE PULLEY NYLON WHEEL



ITEM CODE	SIZE	LENGTH	WIDTH	THICKNESS	SCREW No	WHEEL DIA	WT/PCS	Pcs In Inner	Pcs In Outer
MPUL0202040	1.75"	112	25	3.0	8	43	0.110	10	100

FINISH AVAILABLE - EXB, TEXTURE BLK, EXW, ZP, DUROSIL, EVERBLACK, HSG

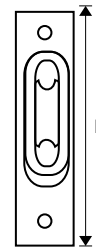

GP202/Q : ROUND END AXLE PULLEY CAST WHEEL



ITEM CODE	SIZE	LENGTH	WIDTH	THICKNESS	SCREW No	WHEEL DIA	WT/PCS	Pcs In Inner	Pcs In Outer
MPUL202Q045	1.75"	111	35	5.0	10	43	0.150	10	100

FINISH AVAILABLE - EXB, TEXTURE BLK, EXW, ZP, DUROSIL, EVERBLACK, HSG

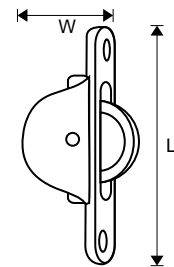

GP261 : SINGLE LINE (AWNING) PULLEY



ITEM CODE	SIZE	LENGTH	WIDTH	THICKNESS	WHEEL DIA	WT/PCS	Pcs In Inner	Pcs In Outer
MPUL0261038	1.5"	100	38	2.2	36	0.084	10	100

FINISH AVAILABLE - EXB, TEXTURE BLK, EXW, ZP, DUROSIL, EVERBLACK, HSG

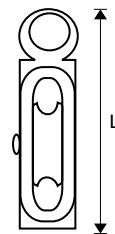

GP268 : SINGLE UPRIGHT PULLEY - WHEEL ACROSS THE PLATE



ITEM CODE	SIZE	LENGTH	WIDTH	THICKNESS	SCREW No	WHEEL DIA	WT/PCS	Pcs In Inner	Pcs In Outer
MPUL0268038	1.5"	70	53	2.2	8	37	0.068	10	100

FINISH AVAILABLE - EXB, TEXTURE BLK, EXW, ZP, DUROSIL, EVERBLACK, HSG

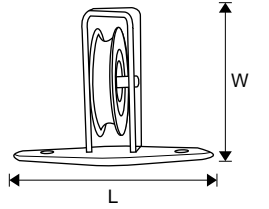

GP268A : SINGLE UPRIGHT PULLEY WHEEL ALONG THE PLATE



ITEM CODE	SIZE	LENGTH	WIDTH	THICKNESS	SCREW No	WHEEL DIA	WT/PCS	Pcs In Inner	Pcs In Outer
MPUL268A038	1.5"	70	53	2.2	8	37	0.066	10	100

FINISH AVAILABLE - EXB, TEXTURE BLK, EXW, ZP, DUROSIL, EVERBLACK, HSG

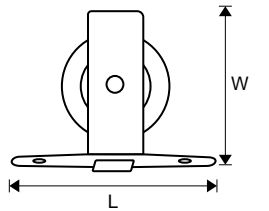

GP202C : CAST IRON SASH PULLEY CAST WHEEL



ITEM CODE	SIZE	LENGTH	WIDTH	THICKNESS	SCREW No	WHEEL DIA	WT/PCS	Pcs In Inner	Pcs In Outer
MPUL202C044	1.75"	115	35	4.1	10	45	0.214	10	60

FINISH AVAILABLE - EXB, TEXTURE BLK, EXW, ZP, DUROSIL, EVERBLACK, HSG

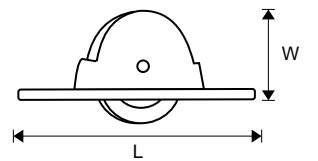

GP202D : SASH PULLEY WITH BRASS WHEEL



ITEM CODE	SIZE	LENGTH	WIDTH	THICKNESS	SCREW No	WHEEL DIA	WT/PCS	Pcs In Inner	Pcs In Outer
MPUL202D044	1.75"	117	39	3.2	6	46	0.152	10	100

FINISH AVAILABLE - POLISHED BRASS & CHROME PLATED FOREND

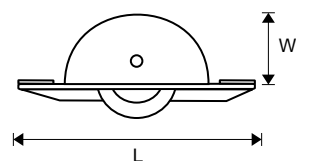

1581 : FAST EYE PULLEY (NICKLE PLATED)



ITEM CODE	SIZE	LENGTH	WIDTH	WHEEL DIA	WT/PCS	Pcs In Inner	Pcs In Outer
MPUL1581019	1.5"	75	36	36	0.130	10	100

FINISH AVAILABLE - EXB, TEXTURE BLK, EXW, ZP, DUROSIL, EVERBLACK, HSG

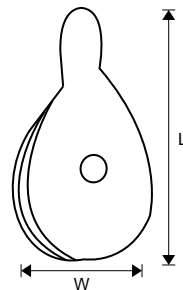

1706: SPRING DOOR STOP



ITEM CODE	LENGTH	WIDTH	SCREW NO.	WT/PCS	Pcs In Inner	Pcs In Outer
MMIH1706076	78	24	6	0.027	10	200

FINISH AVAILABLE - ELECTROBRASS, NICKEL PLATED

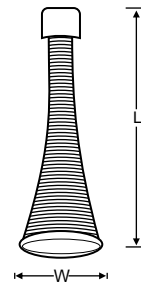

G0051: BLACK ANTIQUE RACK END (LIGHT WEIGHT)

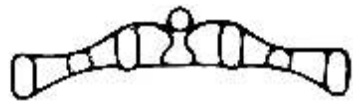

ITEM CODE	SIZE	LENGTH	WIDTH	WT/PCS	Pcs In Inner	Pcs In Outer
CMIH0051363	14"	356	93	0.347	5	50

FINISH AVAILABLE : EXB, EXW, DUROSIL

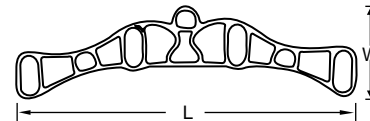

G2001 TO G2005: CLEAT HOOK



DPG CODE	ITEM CODE	SIZE	LENGTH	WIDTH	SCREW NO.	WT/PAIR	Prs In Inner	Prs In Outer
G2002	CMIH2002075	3"	76	25	6	0.053	30	300
G2003	CMIH2003100	4"	100	25	10	0.056	25	250
G2004	CMIH2004125	5"	128	28	10	0.092	25	250
G2005	CMIH2005150	6"	151	28	10	0.103	25	150

FINISH AVAILABLE : EXB, EXW, DUROSIL
SIZE AVAILABLE IN 50MM (G2001)

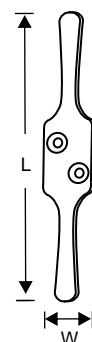

IRONMONGERY FITTINGS

DESCRIPTION	PAGE No.	DESCRIPTION	PAGE No.
ACCESSORIES FOR BOLT	10	DOOR SPRING	17
AUTO LOCK PIG BOLT	12	DOOR STOPPER LARGE	35
AUTOMATIC GATE CATCH STEEL CASE & PEG	13	DOOR STOPPER SMALL	35
AUTOMATIC GATE CATCH STEEL CASE MALLEABLE IRON PEG ,HEAVY	13	DOUBLE SCREW PULLEY	36
AXLE PULLEY NYLON WHEEL	37	FAST EYE PULLEY(NICKLE PLATED)	39
AXLE PULLEY WITH PLATE, NYLON WHEEL FOREND	37	FIELD GATE SHOOT BOLT	12
BARREL BOLT	4	FITCH FASTENER	20
BARREL BOLT	4	FLANGE BRACKET	31
BARREL BOLT NECKED HEAVY	2	FLUTED ANGLE BRACKET	28
BARREL BOLT NECKED LIGHT	2	FOOT BOLT	9
BLACK ANTIQUE RACK END (LIGHT WEIGHT)	39	GARAGE DOOR BOLT WITH RECEIVER PLATE ,LIGHT	10
BOLT LIGHT	1	GARAGE DOOR HOLDER FOR NARROW LINTELS	26
BOW HANDLE BOLT	8	GARAGE DOOR HOLDER JUNIOR FOR WIDE LINTELS	26
CABIN HOOK	2	GARAGE DOOR HOLDER SENIOR FOR WIDE LINTELS	26
CABIN HOOK SQUARE PLATE (MALLEABLE)	22	GATE LATCH PLAIN BIG RING HANDLE	16
CABIN HOOK(EXTRA LONG)	21	GATE LATCH PLAIN BIG RING HANDLE,HEAVY	16
CANE BOLT	12	GATE LATCH PLAIN RING HANDLE	15
CASEMENT FASTENER (WEDGE)	19	GATE LATCH TWISTED RING HANDLE	15
CASEMENT STAY (WITH 2 NOS. 5/16" PINS)	18	HANDRAIL BRACKET	27
CASEMENT STAY WITH 1 FLAT CENTRE & 1 OFFSET PIN)	18	HANDRAIL BRACKET ADJUSTABLE BENDED/STRAIGHT	27
CASEMENT STAY WITH 9 CENTRE & 9 OFFSET PIN	18	HANDRAIL BRACKET FIX BENDED (EURO)	27
CAST IRON SASH PULLEY CAST WHEEL	38	HEAVY BARREL BOLT	5
CHAIN BOLT REVERSIBLE SPRING LOADED SHOOT	9	HIGH DOME TOWER BOLT	3
CHEST HANDLE	34	HOT BED HANDLE	34
CLEAT HOOK	39	KEEPS FOR BOLT	8
CONNECTING BRACKET	32	KEEPS FOR PADBOLT	5
CORNER BRACES HEAVY COUNTER SUNK	28	LOCKING CASEMENT FASTENER	19
CORNER BRACES LIGHT COUNTER SUNK	28	LOCKING CASEMENT STAY	19
CORNER BRACKET	32	LOCKING CASEMENT STAY (MODERN)	19
CORNER PLATE	29	STEEL LOCKING GARAGE DOOR BOLT	11
CROSS DOOR BOLT	11	LOCKING HASP AND STAPLE	25
DOOR BOLT	10	MALLEABLE CABIN HOOK TWISTED (MALLEABLE)	22
DOOR BOLT FOR PADLOCK	6	MALLEABLECABIN HOOK OVAL PLATE(MALLEABLE)	22

IRONMONGERY FITTINGS

DESCRIPTION	PAGE No.	DESCRIPTION	PAGE No.
MENDING PLATE	30	SINGLE SCREW PULLEY	36
MENDING PLATE HEAVY	30	SINGLE UPRIGHT PULLEY-WHEEL ACROSS THE PLATE	38
MINI MOUNT	35	SINGLE UPRIGHT PULLEY-WHEEL ALONG THE PLATE	38
MIRROR PLATE PLAIN	33	SLIDING ACTION BOLT DOUBLE LOCKING	8
MIRROR PLATE SLOTTED	33	SLIMLINE PADBOLT	7
MONKEY TAIL BOLT	9	SLOT PLATE HEAVY (HORIZONTAL/ VERTICAL)	31
NECKED TOWER BOLT	3	SLOT PLATE LIGHT (HORIZONTAL/ VERTICAL)	31
OVAL PADBOLT	6	SOLID LID STAY	39
OVAL PADBOLT	7	SPRING DOOR STOP	20
OWER BOLT	3	SPRING LOADED ANIMAL BOLT	13
PADBOLT, BRENTON PATTERN, HEAVY	5	SPRING LOADED ANIMAL BOLT C/W STAPLE	13
PADBOLT, BRENTON PATTERN, MEDIUM	6	STAINLESS STEEL BOLT HEAVY	1
PADBOLT, MEDIUM	7	STEEL HEAVY GARAGE DOOR BOLT WITH RECEIVER PLATE	11
PADLOCK PROTECTION BARS- LEFT/ RIGHT HANDED	25	STEEL SUFFOLK LATCH HEAVY	14
PEGS FOR AUTOMATIC GATE CATCH	14	STRETCHER PLATE	29
PINS FOR CASEMENT STAY (OFFSET & CENTER)	18	STRETCHER PLATE (LIGHT)	29
PULL HANDLE (HEAVY)	34	SUFFOLK LATCH	14
QUADRANT STAY - LEFT HANDED/RIGHT HANDED	33	SUFFOLK LATCH (KEEP, CATCH & T BAR)	15
RIDGE PLATE	33	SURFACE LATCH	17
RING GATE LATCH SPARES (KEEP & CATCH)	17	SWIVEL LOCKING BAR	25
RING ONLY	17	TABLE BRACE PLATE(LARGE PATTERN)	35
ROUND CORNER BRACKET	29	TEE PLATE	30
ROUND END AXLE PULLEY CAST WHEEL	37	TOP FLAP STAY	20
SAFETY HASP AND STAPLE EXTRA LIGHT PATTERN	23	TOWER BOLT	1
SAFETY HASP AND STAPLE HEAVY PATTERN	24	TUBULAR HANDLE	34
SAFETY HASP AND STAPLE	24	TURN BUTTON	22
SAFETY HASP AND STAPLE MEDIUM PATTERN	24	TWISTED BRACKET	32
SASH FASTENER	21	TWISTED SUPPORT BRACKET	35
SASH PULLEY WITH BRASS WHEEL	38	VERTICAL HASP AND STAPLE	25
SECTIONAL TOWER BOLT	4	WENDY HOUSE LATCH	16
SHED SECURITY BAR	26	WINDOW FASTENER	20
SINGLE CLOTHES LINE PULLEY	36	WIRE CABIN HOOK	21
SINGLE CLOTHES LINE PULLEY	36	WIRE HASP AND STAPLE	23
SINGLE LINE(AWNING) PULLEY	37	WIRE HASP AND STAPLE LIGHT PATTERN	23
		Z BRACKET	32

IRONMONGERY FITTINGS

ITEM CODE	PAGE No.	ITEM CODE	PAGE No.	ITEM CODE	PAGE No.	ITEM CODE	PAGE No.
20	14	1822	13	4A	6	G2001	39
66	9	1835	13	4ASA	7	G2002	39
68	9	1836	12	54/4	14	G2003	39
146	25	6553	31	585S	33	G2004	39
147	25	70070	32	5A	6	G2005	39
149	24	70080	35	60BHB	8	G2099	22
213	12	70090	35	60MTB	9	G2099A	22
218	29	71705	35	617EL	23	G2100	22
236	27	71706	34	6A	7	G2100A	22
246	34	1100A	34	791NSS	2	G2101	22
258	34	1100B	35	7A	12	G2101A	22
315	29	1100L	34	887SS	1	G2102	22
318	30	1100S	16	888NSS	2	G2102A	22
324	29	1136A	16	888SS	1	G2103	22
325	30	1136BR	16	889NSS	2	G2103A	22
326	32	1136EH	16	889SS	1	G2104	22
327	32	1258H	5	890NSS	2	G2104A	22
329	32	1260H	11	890SS	1	GLH001	25
331	33	1260HLK	11	891HSS	1	GP039	36
401	35	1260L	10	891NSS	2	GP042	36
497	20	1261SS	2	891SS	1	GP202	37
498	20	149LW	23	892NSS	2	GP202/Q	37
500	17	149M	24	892SS	1	GP202C	38
585	33	149W	23	893NSS	2	GP202D	38
597	11	151LH/RH	25	893SS	1	GP260	36
617	24	1A	5	894NSS	2	GP260A	36
780	35	202A	37	894SS	1	GP261	37
790	33	236AB/AS	27	895NSS	2	GP268	38
925	3	236FB	27	895SS	1	GP268A	38
1010	26	258H	34	923A	3	GZC2001	19
1011	26	2A	6	923H	4	GZC2005	19
1012	26	2ASA	7	923N	3	GZC2021	19
1100	34	316/317	31	923SA	4	GZC2025	19
1131	17	316A/317A	31	923SS	1	GZC2031	20
1136	15	319H	28	G0051	39	GZC2071	21
1141	15	319L	8	G0420	22	GZC3035	5
1247	28	319RC	4	G0421	22	SPARES	8
1257	8	325H	29	G1800	22	20/4	15
1258	4	478A	30	G1801	22	SPARES	17
1259	10	478B	18	G1802	22	SPARES	17
1261	21	478C	18	G1803	22	SPARES	18
1262	21	482-485	10			SPARES	14
1581	39					SSB001	26
1706	39						
1819	13						

NOTE

* All Weight Given are Approximate and can Vary

* All Data & Photos Printed In This Catalogue Represent The Product to Close Details, However There May Be Some Variations in Real Product & Photograph.

* All Information and Photograph is Property of **D. P. GARG PVT. LTD.**
It is illegal to reproduce any photograph & data without prior written consent of the company.

KEY FINISHES

BZP	BRIGHT ZINC PLATED
EXB	EPOXY BLACK
EXW	EPOXY WHITE
HSG	HOT SPLETER GALVANIZED
TEXTURE BLK	TEXTURE BLACK
DURO SIL	DURO SILVER
EVERBLK	EVER BLACK