

Other Product Range

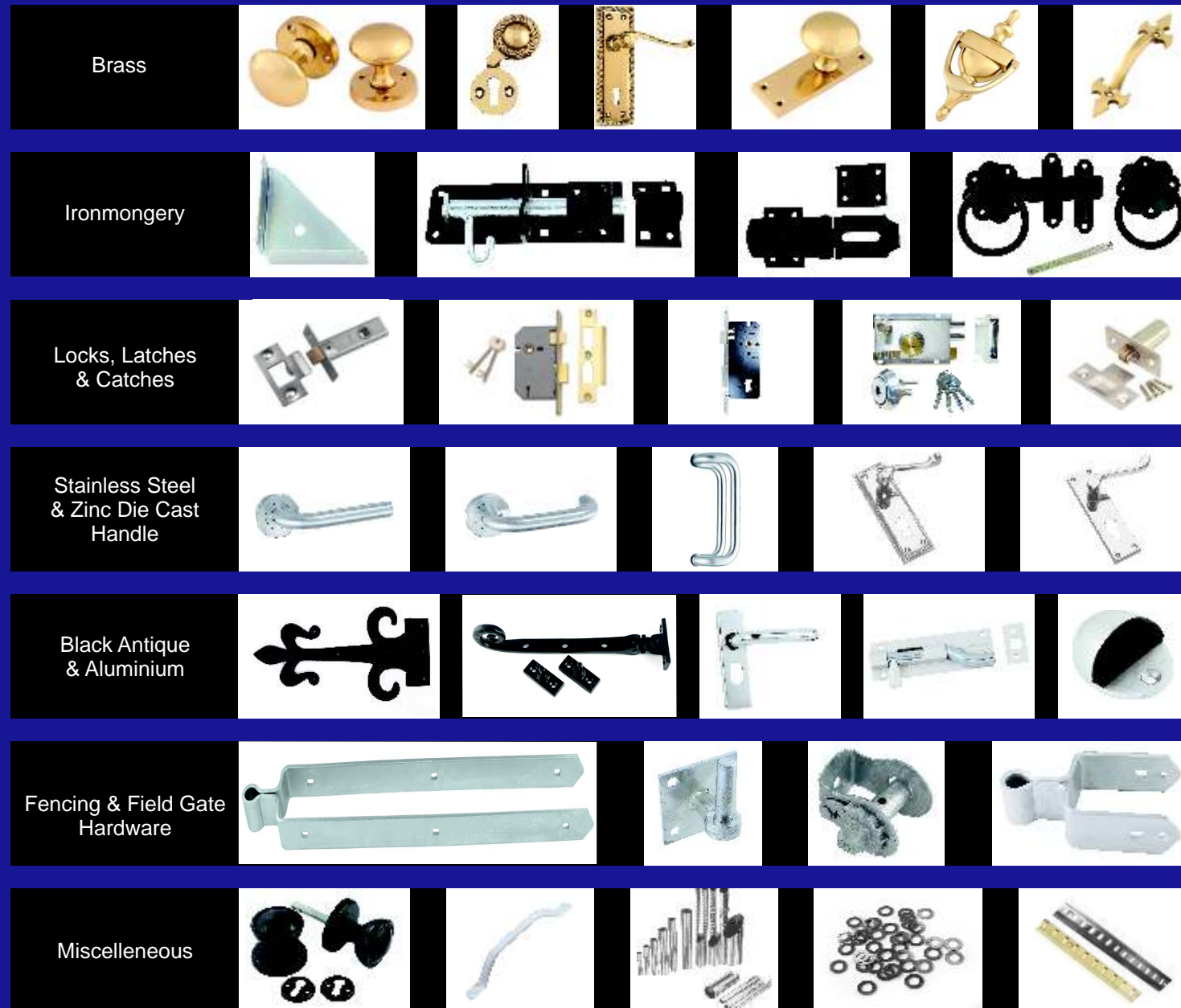

An ISO : 9001 : 2008 , 14001 : 2004, 18001 : 2007 Certified Company

A Government of India Recognised Star Export House

B-210 B, Phase - 2, Noida - 201305 (U.P.) INDIA

Ph.: +91-120-2460071, 2460085 to 87, 3290544, 3290445 Fax : +91-120-2460083, 2424519, 2424452

Email : smg@garg-hinges.com

Visit us at : www.garg-hinges.com, www.garglocks.co.in , www.elitelocks.co.in

Garg

ISO 9001 : 2008 CERTIFIED COMPANY

Hinges

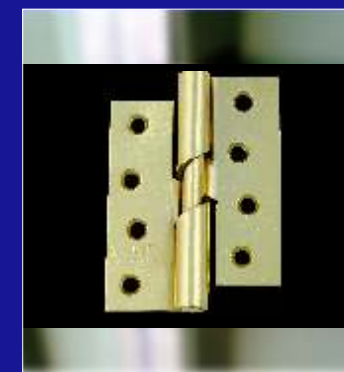

Quality the World Trusts



MILD STEEL HINGES

CODE	DESCRIPTION	PAGE
1838	STEEL BUTT HINGE CRANKED KNUCKLE, FIXED PIN	01
1840	STEEL BUTT HINGE CRANKED KNUCKLE, REMOVABLE PIN	01
5050	STEEL NARROW BUTT HINGE UNCRANKED KNUCKLE F/P	01
451	STEEL STRONG BUTT HINGE CRANKED KNUCKLE, F/P	02
G-200	CAST BUTT HINGE	02
451DPBW	DOUBLE PHOSPHOROUS BRONZE WASHERED HINGE	02
451DSW	DOUBLE STEEL WASHERED HINGE	03
899	STEEL EXTRA STRONG DOUBLE FLAP BUTT HINGE	03
457	STEEL LIFT OFF HINGE - HANDED CRANKED KNUCKLE	03
466	STEEL RISING BUTT HINGE - HANDED	04
458RC	STEEL RADIUS CORNER HINGE - HANDED	04
488	STEEL PARLIAMENT HINGE UNCRANKED KNUCKLE F/P	04
1951	STEEL STROMPROOF BUTT HINGE	05
195FF	STROMPROOF HINGE	05
195EH	STROMPROOF HINGE (EXTRA HOLES)	05
3207	STROM PROOF HINGE WITH GAP(1951CR)	06
459	STEEL SUPPORTING HINGE OR OFFSET HINGE-HANDED	06
460	STEEL JOURNAL SUPPORT HINGE - HANDED	06
451BB	STEEL BUTT HINGE 2/4 BEARINGS & BUTTON TIP PIN	07
804BB	STEEL SQUARE BUTT HINGE 2/4 BEARINGS	07
804H	STEEL SQUARE HEAVY BUTT HINGE CRANKED KNUCKLE	07
452DS/FP	STEEL BUTT HINGES WITH DOUBLE SECURITY PIN	08
400	STEEL BACK FLAP (TABLE) HINGE CRANKED KNUCKLE	08
400BP	STEEL BACK FLAP (TABLE) HINGE WITH BENT PIN	08
400UE	STEEL TABLE HINGE UNCRANKED FRENCH SPECIFICATION	09
105	STEEL FLUSH HINGE UNCRANKED KNUCKLE FIX PIN	09
118	CRANKED FLUSH HINGE	09
104FP	STEEL HURLING HINGE-RADIUS CORNER	10
106	STEEL CABINET HINGE FIX PIN	10
108	STEEL CRANKED (EASY HANG) HINGE FIX PIN	10
109	STEEL DOUBLE CRANKED HINGE FIX PIN	11
1386	FANCY CABINET HINGE (BUTTER FLY)	11
1387	SEAT HINGE	11
1841	STEEL BUTT HINGE - AUSTRALIAN SPECIFICATION	12
1842	STEEL BUTT HINGE FRENCH SPECIFICATION	12
804	STEEL SQUARE BUTT HINGE FRENCH SPECIFICATION	12
36	STEEL CONTAINER HINGE	13
101	STEEL CONTINUOUS PIANO HINGE	13
38	STEEL BULLET HINGE	13
121A	LIGHT TEE HINGE UNCRANKED KNUCKLE FIX PIN	14
119P	LIGHT TEE HINGE -PREMIUM UNCRANKED KNUCKLE F/P	14
121M	MEDIUM TEE HINGE UNCRANKED KNUCKLE FIX PIN	14
120P	PREMIUM MEDIUM TEE HINGE	15
121H	HEAVY TEE HINGE UNCRANKED KNUCKLE FIX PIN	15
120	STRONG TEE HINGE UNCRANKED KNUCKLE FIX PIN	15
119	SCOTCH TEE HINGE UNCRANKED KNUCKLE FIX PIN	16
868	HEAVY SCOTCH TEE HINGE	16
867	EXTRA STRONG WEIGHTY TEE HINGE	16
910	GRADED TEE HINGE	17
950	STEEL STRAP HINGE UNCRANKED KNUCKLE	17
30	STEEL STRAP HINGE - MEDIUM WEIGHT	17
950H	STEEL STRAP HINGE - HEAVY WEIGHT	18
234	GATE HOLD BACK HINGE/PENTURE DE GONDS	18
1055	HOOKS AND BANDS HINGE (STRAIGHT)	18

CODE	DESCRIPTION	PAGE
128	HOOK AND BAND HINGE (PREMIUM)	19
1056	HOOK AND BAND HINGE (CRANKED)	19
130	PREMIUM HOOK AND BAND HINGE (CRANKED)	19
1055L	LIGHT HOOK AND BAND HINGE (STRAIGHT)	20
1056L	LIGHT HOOK AND BAND HINGE (CRANKED)	20
1057	ADJUSTABLE HOOK AND BAND HINGE	20
140	HOOK ON BACK PLATE TO SUIT ADJ. BAND	21
112G	HOOK ON BACK PLATE TO SUIT ADJ. BAND	21
499	STEEL REVERSIBLE HINGE WITH CAST IRON CUP	21
499LW	STEEL LIGHT WEIGHT REVERSIBLE HINGE	21
499C	CUP ONLY REVERSIBLE HINGE	22
1056C/D	HOOK AND BAND (DECORATIVE SQUARE TAIL)	22
7182	ESTATE PATTERN BAND	22
1061	SHORT HINGE	22
GF0251	BARREL HINGE	23

CABINET HINGES

GF111	CABINET HINGE SPRUNG (26MM)	23
GF112	CABINET HINGE SPRUNG (35MM)	23
GF201	SURFACE MOUNT SPRUNG HINGE (100MM)	23
GF115	CLIP ON CONCEALED HINGE 35MM (90 DEGREES)	23
GF101	CABINET HINGE UNSPRUNG (26MM)	23
GF102	CABINET HINGE UNSPRUNG (35MM)	23
GF151	CABINET HINGE SPRUNG (170 DEGREES)	23
GF155	CLIP ON CABINET HINGE SPRUNG (170 DEGREES)	23

STAINLESS STEEL HINGES

551SSBB	STAINLESS STEEL CE13 HINGE	24
551SSBB	STAINLESS STEEL CE11 HINGE	25
551SSBB	STAINLESS STEEL CE7 HINGE	26
551BB(SSP/DSP)	SS BB SINGLE/DOUBLE SECURITY PINS HINGE	
GZC1201	CONCEALED HINGE	27
2451	SICHERN HINGE	28
453	STAINLESS STEEL BUTT HINGE	28
451SS	STAINLESS STEEL STRONG BUTT HINGE	28
551W	SS BUTT HINGE DOUBLE WASHERED - HEAVY DUTY	29
466SS	STAINLESS STEEL RISING BUTT HINGE - HANDED	29
105SSBB	STAINLESS STEEL FLUSH HINGE 2 BB & BUTTON TIP	29
459SS	STAINLESS STEEL SUPPORTING HINGE	30
458SSRC	STAINLESS STEEL RADIUS CORNER HINGE - HANDED	30
3210SS	STAINLESS STEEL PARLIAMENT HINGE	30

BRASS HINGES

GB1200	BRASS EXTRUDED BUTT HINGE	31
GB1300	BRASS BUTT HINGE WITH DOUBLE STEEL WASHERS	32
GB1301	DPBW BRASS HINGE	33
GB1401	BRASS BUTT HINGE WITH 2/4 BOTTON TIP HEAD SS PIN	33
GB1405	BRASS BUTT HINGE WITH 2/4 BOTTON TIP HEAD SS PIN	34
GB1351	BRASS SQUARE BUTT HINGE	34
GB1500	BRASS SQUARE BUTT HINGE WITH DOME HEAD PIN	34
GB1501	BRASS BUTT HINGE (TOMB HEAD)	34
GB1601	BRASS BUTT HINGE WITH 2 BB & FINNIAL HEAD SS PIN	35
GB2201	BRASS BUTT HINGES ACRON TIP SS PIN	35
GB1701	BB BUTT HINGE (DOUBLE SECURITY PIN)	35
GB1801	BRASS REFLECT HINGE-HANDED	35
GB1901	BRASS REFLECT HINGE WITH FLAT FLUSH/ROUND HEAD	36
GB2098	BRASS "H" HINGE	36
GB2301	BRASS RADIUS CORNER ROUND HEAD	36
GB2400	BRASS CRANKED HINGE 2 BALL BEARING (SS PIN)	36

CODE	DESCRIPTION	PAGE
GB3151	BRASS COUNTER HINGE	37
GB3210	BRASS PARLIAMENT HINGE	37
GB3210A	BRASS PARLIAMENT HINGE	37
GB0101	BRASS CONTINUOUS PIANO HINGE	37
GB1811	BRASS REFLUX HINGE	38
GB2451	BRASS SNAKE HINGE	38

BLACK ANTIQUE HINGES

G1302	BLACK ANTIQUE BUTTER FLY HINGE	38
G0206	BLACK ANTIQUE UNEQUAL HINGE	38
G0017	BLACK ANTIQUE LIGHT DUTY HINGE	39
G0201	BLACK ANTIQUE ORNATE HINGE	39
G0205	BLACK ANTIQUE ORNATE CORONET HINGE	39
G0208	BLACK ANTIQUE HEAVY PLAIN HINGE	39
G0005	BLACK ANTIQUE PLAIN HINGE	40
G0011	BLACK ANTIQUE FLEUR-DE-LYS CLAW HINGE	40
G0050	BLACK ANTIQUE CLAW HINGE	40
	ALPHABETICAL INDEX	41
	DPG CODE INDEX	42

NOE : ALL WEIGHT GIVEN IN KGS & LENGTHS IN MM UNLESS MENTIONED



1838 : STEEL BUTT HINGES CRANKED KNUCKLE, FIXED PIN



ITEM CODE	SIZE	LENGTH	WIDTH	THICKNESS	N.H.	Screw No.	WT/PAIR	Prs In Inner	Prs In Outer
MHIN1838025	1"	25	25	1.2	4	4	0.016	25	1400
MHIN1838040	1.5"	40	33	1.3	4	4	0.035	10	600
MHIN1838050	2"	50	36	1.4	4	6	0.056	10	400
MHIN1838065	2.5"	65	44	1.4	6	6	0.082	10	250
MHIN1838075	3"	75	49	1.4	6	7	0.111	10	200
MHIN1838090	3.5"	90	56	1.75	6	8	0.190	10	100
MHIN18380100	4"	100	71	1.75	8	8	0.260	5	80
MHIN18380150	6"	150	98	2.15	8	10	0.740	5	30

FINISH AVAILABLE - SC, BZP, ARJUNA, YPZP, EB, EXB, EXW, CP, SNP, ANTIQUE BRASS, DUROSIL
Also Available in rounded corner Code 1838 RC

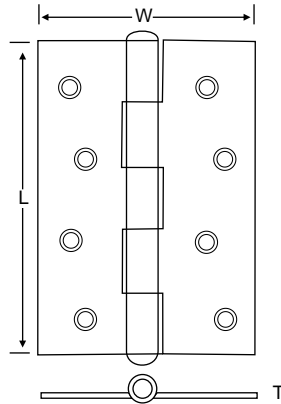

451 : STEEL STRONG BUTT HINGES CRANKED KNUCKLE, FIXED PIN



ITEM CODE	SIZE	LENGTH	WIDTH	THICKNESS	SCREW No.	WT/PAIR	Prs In Inner	Prs In Outer
MHIN0451050	2"	50	42	2.5	8	0.115	10	200
MHIN0451075	3"	76	64	2.5	10	0.270	10	80
MHIN0451100	4"	101	75	2.6	10	0.420	5	50
MHIN451H100	4"	101	76	3.55	12	0.550	5	40

FINISH AVAILABLE - SC, BZP, ARJUNA, YPZP, EB, EXB, EXW, CP, SNP, ANTIQUE BRASS, DUROSIL
ALSO AVAILABLE IN ROUNDED CORNER CODE 451 RC,

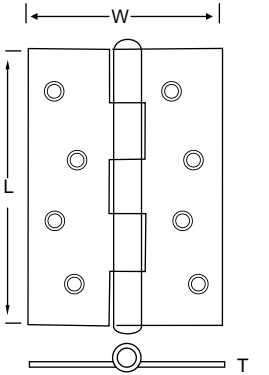

1840 : STEEL BUTT HINGES CRANKED KNUCKLE, REMOVABLE PIN

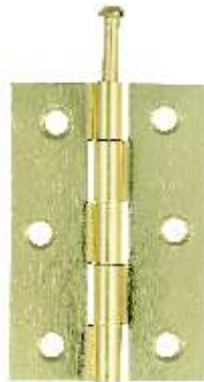

ITEM CODE	SIZE	LENGTH	WIDTH	THICKNESS	SCREW NO.	WT/PAIR	Prs In Inner	Prs In Outer
MHIN1840050	2"	50	36	1.4	6	0.056	10	400
MHIN1840065	2.5"	65	44	1.4	6	0.082	10	250
MHIN1840075	3"	75	49	1.4	7	0.111	10	200
MHIN1840090	3.5"	90	57	1.75	8	0.190	10	100
MHIN1840100	4"	100	71	1.75	8	0.260	5	80

FINISH AVAILABLE - SC, BZP, ARJUNA, YPZP, EB, EXB, EXW, CP, SNP, ANTIQUE BRASS, DUROSIL
ALSO AVAILABLE IN ROUNDED CORNER CODE 1840 RC

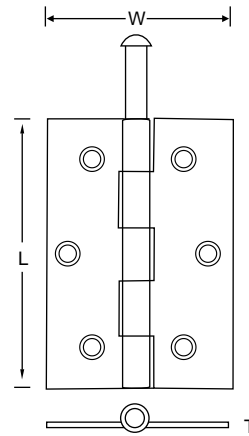

G-200 : CAST BUTT HINGE



ITEM CODE	SIZE	LENGTH	WIDTH	SCREW NO.	WT/PAIR	Prs In Inner	Prs In Outer
CHIN1297050	2"	51	43	8	0.064	20	240
CHIN1298065	2.5"	65	49	8	0.110	20	160
CHIN1299075	3"	76	54	8	0.148	20	120
CHIN1301100	4"	103	58	8	0.200	10	80

FINISH AVAILABLE : SC & EXB

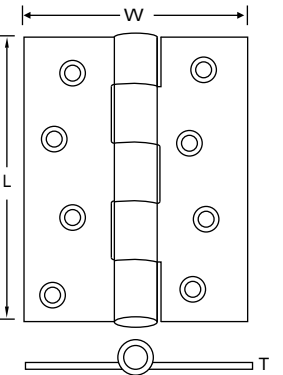

5050 : STEEL NARROW BUTT HINGES UNCRANKED KNUCKLE, FIXED PIN



ITEM CODE	SIZE	LENGTH	WIDTH	THICKNESS	N.H.	Screw No.	WT/PAIR	Prs In Inner	Prs In Outer
MHIN5050025	1"	25	24	1.2	4	4	0.016	25	1400
MHIN5050040	1.5"	40	31	1.4	4	4	0.035	10	600
MHIN5050050	2"	50	37	1.5	6	6	0.056	10	400
MHIN5050065	2.5"	65	41	1.5	6	6	0.085	10	250
MHIN5050075	3"	75	47	1.7	6	7	0.126	10	160
MHIN5050090	3.5"	90	54	1.7	6	7	0.190	10	100
MHIN5050100	4"	100	58	1.9	8	8	0.254	5	80
MHIN5050125	5"	125	65	2.12	8	8	0.376	5	50
MHIN5050150	6"	150	75	2.24	8	10	0.570	5	30

FINISH AVAILABLE - SC, BZP, ARJUNA, YPZP, EB, EXB, EXW, CP, SNP, ANTIQUE BRASS, DUROSIL

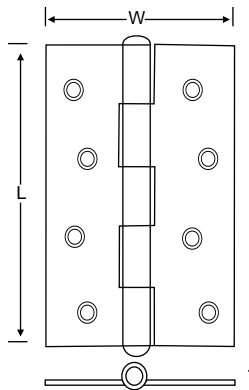

451 DPBW : DOUBLE PHOSPHOROUS BRONZE WASHERED HINGES



ITEM CODE	SIZE	LENGTH	WIDTH	THICKNESS	Screw No.	WT/PAIR	Prs In Inner	Prs In Outer
MHIN1451175	3"	75	48	2.0	7	0.150	10	80
MHIN1451100	4"	101	75	2.5	10	0.416	5	50

FINISH AVAILABLE - SC, BZP, ARJUNA, YPZP, EB, EXB, EXW, CP, SNP, ANTIQUE BRASS, DUROSIL

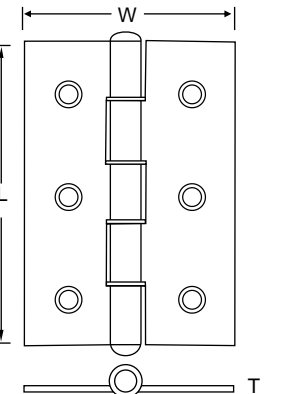

451 DSW : DOUBLE STEEL WASHERED HINGES



ITEM CODE	SIZE	LENGTH	WIDTH	THICKNESS	Screw No.	WT/PAIR	Prs In Inner	Prs In Outer
MHIN1452075	3"	75	48	2.0	7	0.150	10	80
MHIN1452100	4"	101	75	2.5	10	0.416	5	50

FINISH AVAILABLE - SC, BZP, ARJUNA, YPZP, EB, EXB, EXW, CP, SNP, ANTIQUE BRASS, DUROSIL

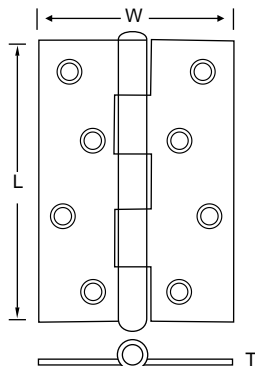

466 : STEEL RISING BUTT HINGES HANDED- CRANKED KNUCKLE LIFT- OFF PATTERN, FLUSH PIN



ITEM CODE	SIZE	LENGTH	WIDTH	THICKNESS	Screw No.	WT/PAIR	Prs In Inner	Prs In Outer
MHIN466L075	3"	76	73	2.55	8	0.320	5	70
MHIN466L100	4"	100	80	2.8	10	0.560	5	35

FINISH AVAILABLE - SC, BZP, ARJUNA, YPZP, EB, EXB, EXW, CP, SNP,

ANTIQU BRASS , DUROSIL

AVAILABLE IN : L/H & R/H

Note : Also available in Stainless Steel 18/8 (Gr. - 304) Code 466 SS

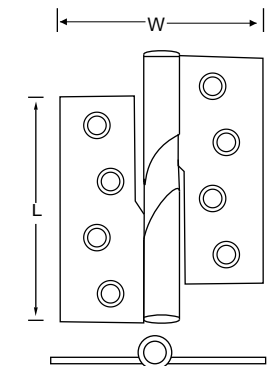

899 : STEEL EXTRA STRONG DOUBLE FLAP BUTT HINGES UNCRANKED KNUCKLE, FIXED PIN



ITEM CODE	SIZE	LENGTH	WIDTH	THICKNESS	Screw No.	WT/PAIR	Prs In Inner	Prs In Outer
MHIN0899075	3"	76	60	4.0	10	0.300	10	60
MHIN0899100	4"	101	72	4.3	12	0.500	5	40
MHIN0899150	6"	152	102	6.0	12	1.610	2	12

FINISH AVAILABLE - SC, BZP, ARJUNA, YPZP, EB, EXB, EXW, CP, SNP,

ANTIQU BRASS , DUROSIL

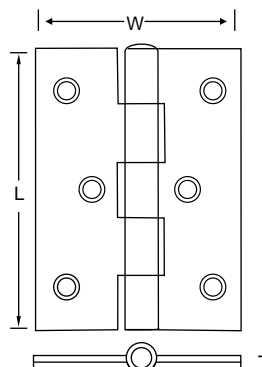

458RC : STEEL RADIUS CORNER HINGES HANDED- CRANKED KNUCKLE, LIFT - OFF



ITEM CODE	SIZE	LENGTH	WIDTH	THICKNESS	Screw No.	WT/PAIR	Prs In Inner	Prs In Outer
MHIN458R080	3"	80	80	2.5	7	0.314	5	80

FINISH AVAILABLE - SC, BZP, ARJUNA, YPZP, EB, EXB, EXW, CP, SNP,

ANTIQU BRASS , DUROSIL

L/H & R/H ALSO AVAILABLE

Note : Also available in Stainless Steel 18/8 (Gr. - 304) Code 458 SSRC

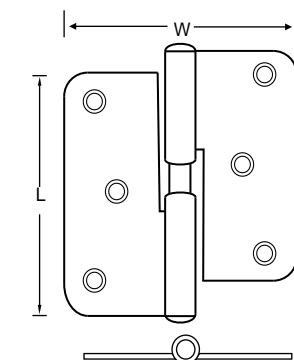

457 : STEEL LIFT OFF HINGES - HANDED CRANKED KNUCKLE



ITEM CODE	SIZE	LENGTH	WIDTH	THICKNESS	Screw No.	WT/PAIR	Prs In Inner	Prs In Outer
MHIN457L065	2.5"	65	52	2.0	8	0.135	10	120
MHIN457L075	3"	75	56	2.6	10	0.230	10	80
MHIN457L100	4"	100	73	2.6	10	0.382	5	50

FINISH AVAILABLE - SC, BZP, ARJUNA, YPZP, EB, EXB, EXW, CP, SNP,

ANTIQU BRASS , DUROSIL

AVAILABLE IN : L/H & R/H

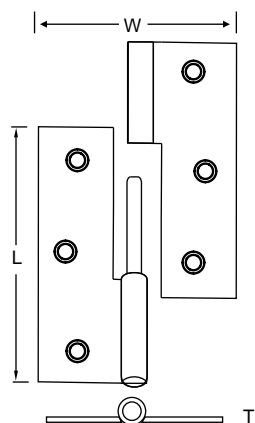

488 : STEEL PARLIAMENT HINGES UNCRANKED KNUCKLE, FIXED PIN



ITEM CODE	SIZE	LENGTH	WIDTH	THICKNESS	Screw No.	WT/PAIR	Prs In Inner	Prs In Outer
MHIN0488050	2"	100	50	2.24	8	0.285	10	80
MHIN0488065	2.5"	100	65	2.24	8	0.305	10	70
MHIN0488075	3"	100	75	2.24	8	0.312	5	70
MHIN0488100	4"	125	100	2.5	8	0.600	5	35
MHIN0488125	5"	125	125	2.5	10	0.672	5	30
MHIN0488150	6"	125	150	2.5	10	0.716	5	30
MHIN0488200	8"	125	200	2.5	10	0.882	5	20

FINISH AVAILABLE - SC, BZP, ARJUNA, YPZP, EB, EXB, EXW, CP, SNP,

ANTIQU BRASS , DUROSIL

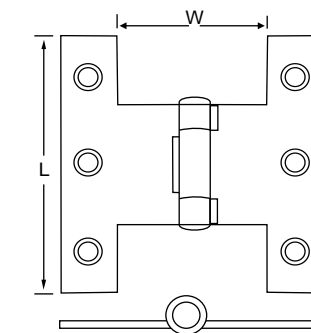

1951 : STEEL STORMPROOF BUTT HINGES FIXED PIN



ITEM CODE	SIZE	LENGTH	WIDTH	THICKNESS	Screw No.	WT/PAIR	Prs In Inner	Prs In Outer
MHIN1951063	2.5"	63	58	1.7	8	0.175	10	120
MHIN1951100	4"	101	72	2.0	8	0.400	5	40

FINISH AVAILABLE - SC, BZP, ARJUNA, YPZP, EB, EXB, EXW, CP, SNP,
ANTIQUE BRASS, DUROSIL

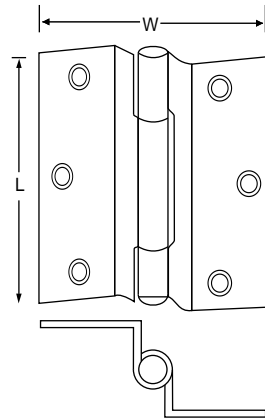

3207 : STORMPROOF HINGE WITH GAP (1951CR)



ITEM CODE	SIZE	LENGTH	WIDTH	THICKNESS	SCREW No.	WT/PAIR	Prs In Inner	Prs In Outer
MHIN3207063	2.5"	63	60	1.6	7	0.154	10	120

FINISH AVAILABLE - SC, BZP, ARJUNA, YPZP, EB, EXB, EXW, CP, SNP,
ANTIQUE BRASS, DUROSIL

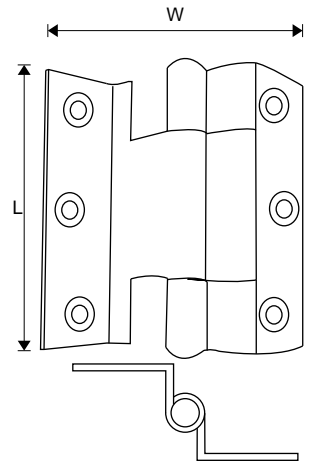

195FF : STORMPROOF HINGES



ITEM CODE	SIZE	LENGTH	WIDTH	THICKNESS	SCREW No.	WT/PAIR	Prs In Inner	Prs In Outer
MHIN1954063	2.5"	63	63	1.8	8	0.180	10	120

FINISH AVAILABLE - SC, BZP, ARJUNA, YPZP, EB, EXB, EXW, CP, SNP,
ANTIQUE BRASS, DUROSIL

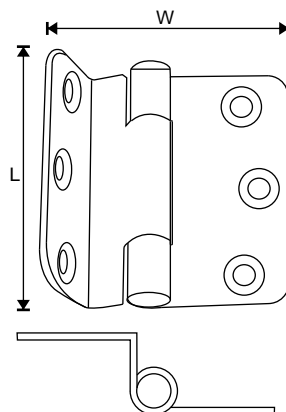

459 : STEEL SUPPORTING HINGES (OR) OFFSET HINGES - HANDED- CRANKED KNUCKLE



ITEM CODE	SIZE	LENGTH	WIDTH	THICKNESS	Screw No.	WT/PAIR	Prs In Inner	Prs In Outer
MHIN459R100	4"	100	86	3.0	10	0.600	5	50
MHIN459R110	4.5"	110	96	3.0	12	0.630	5	50

FINISH AVAILABLE - SC, BZP, ARJUNA, YPZP, EB, EXB, EXW, CP, SNP,
ANTIQUE BRASS, DUROSIL
AVAILABLE IN L/H & R/H

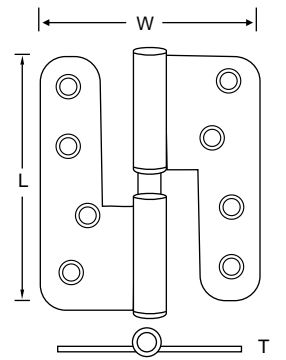

1951EH : STORMPROOF HINGES (EXTRA HOLES)



ITEM CODE	SIZE	LENGTH	WIDTH	THICKNESS	SCREW No.	WT/PAIR	Prs In Inner	Prs In Outer
MHIN1956063	2.5"	63	60	1.8	8	0.180	10	120

FINISH AVAILABLE - SC, BZP, ARJUNA, YPZP, EB, EXB, EXW, CP, SNP,
ANTIQUE BRASS, DUROSIL

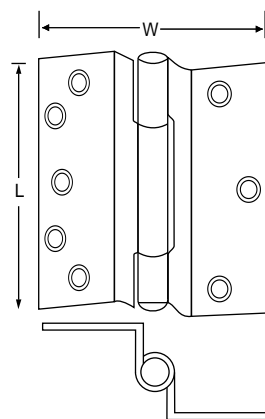

460 : STEEL JOURNAL SUPPORT HINGES HANDED- CRANKED & KNOTCHED KNUCKLE (WITH OIL SLOT)



ITEM CODE	SIZE	LENGTH	WIDTH	THICKNESS	Screw No.	WT/PAIR	Prs In Inner	Prs In Outer
MHIN460L098	4"	98	81	2.5	10	0.435	5	50
MHIN460L110	4.5"	110	98	3.15	10	0.656	5	50

FINISH AVAILABLE - SC, BZP, ARJUNA, YPZP, EB, EXB, EXW, CP, SNP,
ANTIQUE BRASS, DUROSIL
AVAILABLE IN L/H & R/H

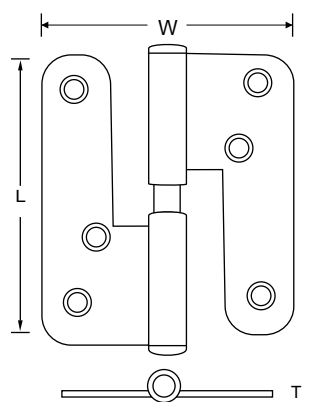

451BB : STEEL BUTT HINGES TWO/ FOUR BEARINGS & BUTTON TIP PIN

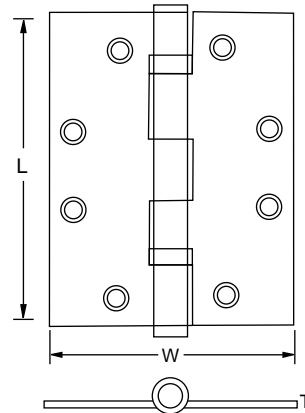

ITEM CODE	SIZE	LENGTH	WIDTH	THICKNESS	Screw No.	WT/PAIR	Prs In Inner	Prs In Outer
MHIN451B075	3"	75	50	2.0	8	0.200	1	100
MHIN0100100	4"	100	75	2.6	10	0.430	1	40

**FINISH AVAILABLE - CHROME PLATED, SATIN CHROME PLATED, MIRROR
BRASS PLATED, FLORENTINE BRONZE, BLACK NICKEL**

452DS/FP : STEEL BUTT HINGES DOUBLE SECURITY PINS

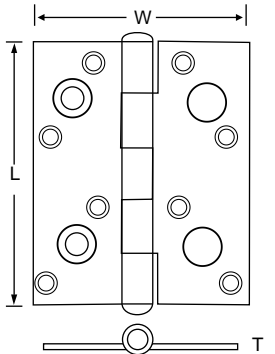

ITEM CODE	SIZE	LENGTH	WIDTH	THICKNESS	SCREW No.	WT/PAIR	Prs In Inner	Prs In Outer
MHIN1452100	4"X3.5"	101	90	2.5	8	0.45	5	50

**FINISH AVAILABLE - SC, BZP, ARJUNA, YPZP, EB, EXB, EXW, CP, SNP,
ANTIQUE BRASS , DUROSIL
Also available - Loose pin (Code 452 DS/LP)**

804BB : STEEL SQUARE BUTT HINGES (HEAVY DUTY) TWO/FOUR BEARINGS & BUTTON TIP PIN

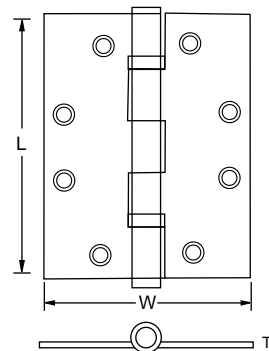

ITEM CODE	SIZE	LENGTH	WIDTH	THICKNESS	Screw No.	WT/PAIR	Prs In Inner	Prs In Outer
MHIN804B114	4.5"x4.5"	114	114	3.4	12	0.866	1	24
MHIN805B114	4.5"x4.5"	114	114	4.5	12	1.172	1	15

**FINISH AVAILABLE - SC, BZP, ARJUNA, YPZP, EB, EXB, EXW, CP, SNP,
ANTIQUE BRASS , DUROSIL**

400 : STEEL BACK FLAP (TABLE) HINGES CRANKED KNUCKLE, FIXED PIN

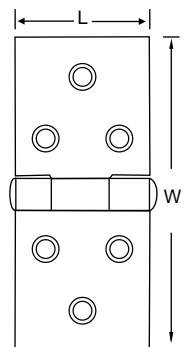
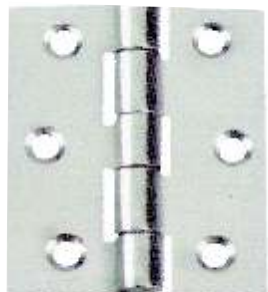

ITEM CODE	SIZE	LENGTH	WIDTH	THICKNESS	Screw No.	WT/PAIR	Prs In Inner	Prs In Outer
MHIN0400025	1"	25	74	1.6	6	0.052	25	400
MHIN0400030	1.25"	30	77	1.6	7	0.062	10	300
MHIN0400040	1.5"	40	87	1.6	8	0.099	10	150
MHIN0400050	2"	50	106	2.0	8	0.182	10	100
MHIN0400060	2.5"	60	132	2.0	8	0.350	10	50
MHIN0400065	2.5"	65	153	2.2	10	0.372	10	50
MHIN0400075	3"	75	168	2.5	10	0.550	5	50

**FINISH AVAILABLE - SC, BZP, ARJUNA, YPZP, EB, EXB, EXW, CP, SNP,
ANTIQUE BRASS , DUROSIL
ALSO AVAILABLE UNCRANKED (404)**

804H : STEEL SQUARE HEAVY BUTT HINGES CRANKED KNUCKLE

ITEM CODE	SIZE	LENGTH	WIDTH	THICKNESS	Screw No.	WT/PAIR	Prs In Inner	Prs In Outer
MHIN8041076	3"X3"	76	76	2.0	8	0.240	10	80
MHIN8041080	3.15"X3.15"	80	80	2.5	8	0.280	10	80
MHIN8041090	3.5"X3.5"	89	89	2.5	8	0.410	5	50
MHIN80410101	4"X4"	101	101	3.1	12	0.640	5	35
MHIN80410101	4"X4.5"	101	114	3.25	12	0.780	5	25
MHIN80410114	4.5"X4.5"	114	114	3.5	12	0.890	5	20

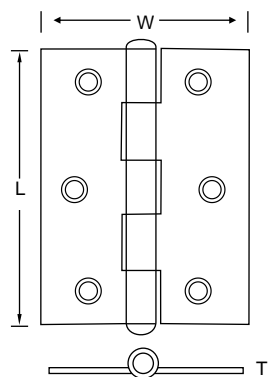
**FINISH AVAILABLE - SC, BZP, ARJUNA, YPZP, EB, EXB, EXW, CP, SNP,
ANTIQUE BRASS , DUROSIL
Also Available in loose pin (Code 804LP) and in Radius Corner (Code 804 HRC)**

400BP : STEEL BACK FLAP (TABLE) HINGES WITH BENT PIN

ITEM CODE	SIZE	LENGTH	WIDTH	THICKNESS	Screw No.	WT/PAIR	Prs In Inner	Prs In Outer
MHIN400B040	1.25"	40	85	1.5	7	0.098	10	150
MHIN400B050	2"	50	104	2.0	8	0.185	10	100

**FINISH AVAILABLE - SC, BZP, ARJUNA, YPZP, EB, EXB, EXW, CP, SNP,
ANTIQUE BRASS , DUROSIL
ALSO AVAILABLE UNCRANKED (404)**

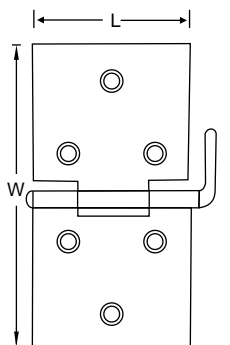

400 UE : STEEL TABLE HINGES UNEVEN FLAPS UNCRANKED (SQUARE/RADIUS CORNERS) (FRENCH SPECIFICATION)



ITEM CODE	SIZE	LENGTH	WIDTH	THICKNESS	Screw No.	WT/PAIR	Prs In Inner	Prs In Outer
MHIN1400045	1.75"	45	80	1.5	6	0.047	20	300
MHIN1400050	2"	50	85	1.5	6	0.055	25	400
MHIN1400075	3"	75	127	2.0	7	0.184	10	150
MHIN1400078	3"	78	32	1.5	7	0.035	20	600

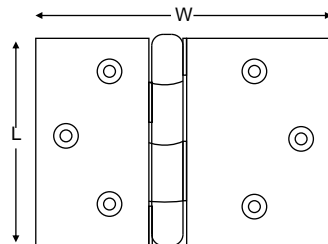

FINISH AVAILABLE - SC, BZP, ARJUNA, YPZP, EB, EXB, EXW, CP, SNP,

ANTIQUÉ BRASS, DUROSIL

* Without Counter, Countersunk can be provided as per choice of buyer.
Also available (400UE RC) Radius Corner

105 : STEEL FLUSH HINGES UNCRANKED KNUCKLE, FIXED PIN



ITEM CODE	SIZE	LENGTH	WIDTH	THICKNESS	Screw No.	WT/PAIR	Prs In Inner	Prs In Outer
MHIN0105038	1.5"	40	32	1.0	4	0.020	25	1200
MHIN0105050	2"	50	38	1.2	4	0.031	25	600
MHIN0105065	2.5"	60	40	1.2	4	0.036	25	500
MHIN0105075	3"	76	52	1.5	6	0.089	25	225
MHIN0105100	4"	100	60	2.0	8	0.228	10	100

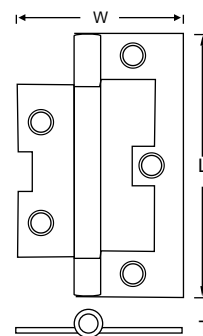

FINISH AVAILABLE - SC, BZP, ARJUNA, YPZP, EB, EXB, EXW, CP, SNP,

ANTIQUÉ BRASS, DUROSIL

Note : Also available in Finial pins (Code 105 FLP) Rounded corners (Code 105 RC)
and Rounded corners with Finial Pins (105 RCF)

118 : CRANKED FLUSH HINGE

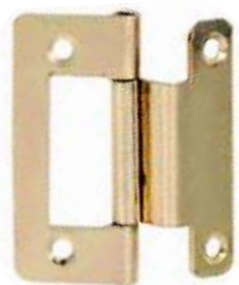

ITEM CODE	SIZE	LENGTH	WIDTH	THICKNESS	SCREW No.	WT/PAIR	Prs In Inner	Prs In Outer
MHIN0118050	2"	51	40	1.2	4	0.040	25	400

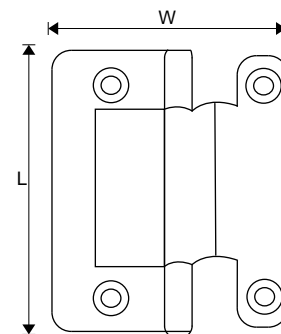

FINISH AVAILABLE - SC, BZP, ARJUNA, YPZP, EB, EXB, EXW, CP, SNP,

ANTIQUÉ BRASS, DUROSIL

104FP : STEEL HURLINGE, RADIUS CORNER CRANKED KNUCKLE, FIXED PIN



ITEM CODE	SIZE	LENGTH	WIDTH	THICKNESS	Screw No.	WT/PAIR	Prs In Inner	Prs In Outer
MHIN1041050	2"	50	34	1.2	4	0.032	25	600
MHIN1041065	2.5"	60	40	1.2	6	0.042	25	500
MHIN1041075	3"	76	51	1.5	7	0.090	25	225
MHIN1041100	4"	101	61	2.0	8	0.180	10	100

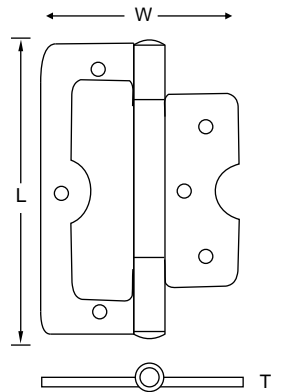

FINISH AVAILABLE - SC, BZP, ARJUNA, YPZP, EB, EXB, EXW, CP, SNP,

ANTIQUÉ BRASS, DUROSIL

Note : Also available in Removable Pin (Code 104 LP)

106 : STEEL CABINET HINGES FIXED PIN



ITEM CODE	SIZE	LENGTH	WIDTH	THICKNESS	Screw No.	WT/PAIR	Prs In Inner	Prs In Outer
MHIN0106065	2.5"	63	60	1.5	6	0.092	25	200
MHIN0106100	4"	100	62	1.5	7	0.140	20	160

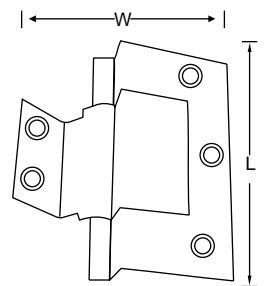

FINISH AVAILABLE - SC, BZP, ARJUNA, YPZP, EB, EXB, EXW, CP, SNP,

ANTIQUÉ BRASS, DUROSIL

108 : STEEL CRANKED (EASY HANG) HINGE FIXED PIN



ITEM CODE	SIZE	LENGTH	WIDTH	THICKNESS	Screw No.	WT/PAIR	Prs In Inner	Prs In Outer
MHIN0108050	2"	51	72	1.2	4	0.060	25	400

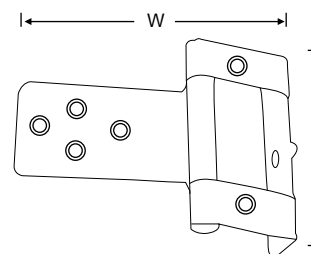

FINISH AVAILABLE - SC, BZP, ARJUNA, YPZP, EB, EXB, EXW, CP, SNP,

ANTIQUÉ BRASS, DUROSIL

109 : STEEL DOUBLE CRANKED HINGE FIXED PIN



ITEM CODE	SIZE	LENGTH	WIDTH	THICKNESS	Screw No.	WT/PAIR	Prs In Inner	Prs In Outer
MHIN0109060	2.5"	60	43	1.6	7	0.115	5	150

FINISH AVAILABLE - SC, BZP, ARJUNA, YPZP, EB, EXB, EXW, CP, SNP,
ANTIQUE BRASS, DUROSIL

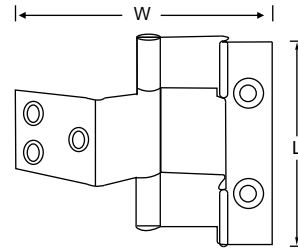

1841 : STEEL BUTT HINGES CRANKED KNUCKLE FIXED / REMOVABLE PIN (AUSTRALIAN SPECIFICATION)



ITEM CODE	SIZE	LENGTH	WIDTH	THICKNESS	SCREW No.	WT/PAIR	Prs In Inner	Prs In Outer
MHIN1841070	2.75"	70	50	1.6	8	0.125	10	200
MHIN1841085	36.5	85	61	1.7	8	0.180	10	150

FINISH AVAILABLE - SC, BZP, ARJUNA, YPZP, EB, EXB, EXW, CP, SNP,
ANTIQUE BRASS, DUROSIL
Also available - Loose pin (Code 452 DS/LP)

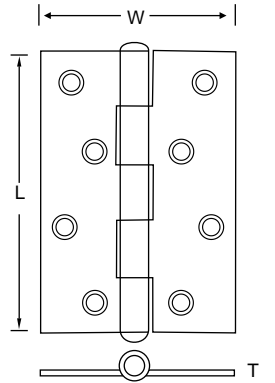

1386 : FANCY CABINET HINGE (BUTTERFLY)



ITEM CODE	SIZE	LENGTH	WIDTH	THICKNESS	SCREW No.	WT/PAIR	Prs In Inner	Prs In Outer
MHIN1386042	1.75"	42	34	1.0	4	0.014	50	1200
MHIN1386051	2"	51	41	1.0	4	0.022	50	1000

FINISH AVAILABLE - SC, BZP, ARJUNA, YPZP, EB, EXB, EXW, CP, SNP,
ANTIQUE BRASS, DUROSIL

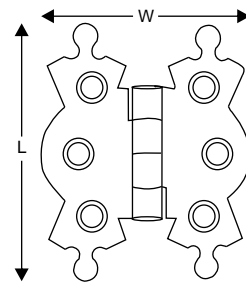

1842 : STEEL BUTT HINGES UNCRANKED KNUCKLE, FIXED PIN (FRENCH SPECIFICATION)

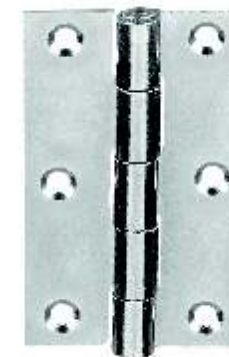

ITEM CODE	SIZE	LENGTH	WIDTH	THICKNESS	SCREW No.	WT/PAIR	Prs In Inner	Prs In Outer
MHIN1842025	1"	25	18	0.8	2	0.004	50	4000
MHIN1842030	1"	30	19	0.8	2	0.005	50	4000
MHIN1842035	1.25"	35	22	0.8	4	0.007	50	4000
MHIN1842040	1.5"	40	25	0.9	4	0.010	50	2500
MHIN1842050	2"	50	30	0.9	4	0.015	25	1500
MHIN1842060	2.5"	60	35	1.0	4	0.022	25	1000
MHIN1842070	2.75"	70	40	1.2	6	0.038	25	500
MHIN1842080	3"	80	45	1.2	7	0.052	25	500
MHIN1842090	3.5"	90	45	1.5	7	0.072	25	300
MHIN18420100	4"	100	50	1.5	7	0.082	25	300

FINISH AVAILABLE - SC, BZP, ARJUNA, YPZP, EB, EXB, EXW, CP, SNP,
ANTIQUE BRASS, DUROSIL
(Also available - In Brass & Stainless Steel)

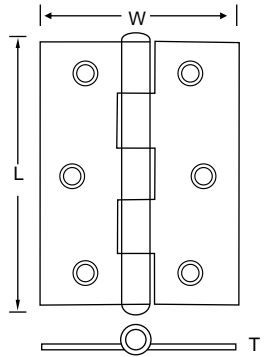

1387 : SEAT HINGE



ITEM CODE	SIZE	LENGTH	WIDTH	THICKNESS	SCREW No.	WT/PAIR	Prs In Inner	Prs In Outer
MHIN1387064	1.5"	38	64	1.0	4	0.044	20	300

FINISH AVAILABLE - SC, BZP, ARJUNA, YPZP, EB, EXB, EXW, CP, SNP,
ANTIQUE BRASS, DUROSIL

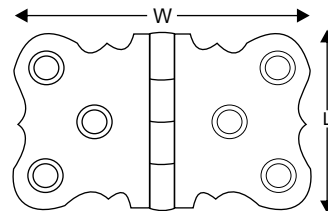

804 : STEEL SQUARE BUTT HINGES UNCRANKED KNUCKLE, FIXED PIN (FRENCH SPECIFICATION)

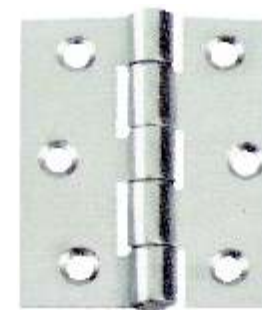

ITEM CODE	LENGTH	WIDTH	THICKNESS	Screw No.	WT/PAIR	Prs In Inner	Prs In Outer
MHIN0804030	30	30	0.80	4	0.008	50	3000
MHIN0804040	40	40	0.90	4	0.015	50	1500
MHIN0804050	50	50	0.90	6	0.023	25	600
MHIN0804060	60	60	1.00	6	0.037	25	500
MHIN0804070	70	70	1.20	7	0.058	25	400
MHIN0804080	80	80	1.20	7	0.071	25	300

FINISH AVAILABLE - SC, BZP, ARJUNA, YPZP, EB, EXB, EXW, CP, SNP,
ANTIQUE BRASS, DUROSIL
Note : Also available in Brass & Stainless Steel

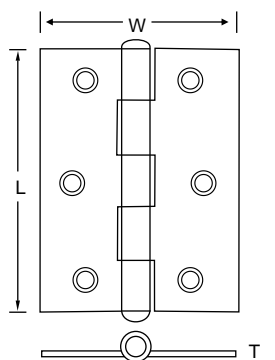

36 : STEEL CONTAINER HINGE



ITEM CODE	SIZE	LENGTH	WIDTH	THICKNESS	Screw No.	WT/PAIR	Prs In Inner	Prs In Outer
MHIN0036180	7"	180	50	4.0	12	0.615	5	50

FINISH AVAILABLE - SC, BZP, ARJUNA, YPZP, EB, EXB, EXW, CP, SNP,
ANTIQU BRASS , DUROSIL

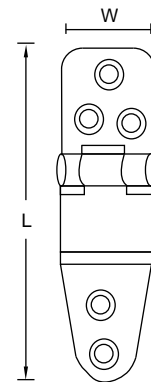

101 : STEEL CONTINUOUS PIANO HINGE (UNCRANKED KNUCKLE, FLUSH PIN)



WIDTH	THICKNESS	LENGTH (MM)	SCREW No.	FINISH AVAILABLE
25,32,40,50	0.60	UPTO 2130	4	ZP,EB,NP,EXBR
25,32,40,50	0.60	UPTO 3500 ZPYP	4	ZP,ZPYP,EB
25,32,35,40,50	0.80	UPTO 2130	4	ZP,NP,OXD,EB,
30,35,40,50	1.20	UPTO 2130	6	ZP,NP,OXD,EB
40,50,60,75	1.60	UPTO 2130	6	ZP,NP,OXD,EB

Notes: Also Available (i) Undrilled piano hinges(codes 101A)
(ii) Stainless steel (Codes 101 SS & 101ASS)
(iii) Steel Cranked Piano Hinges with 12mm gap (Code 101CR)
AVAILABLE IN SOLID BRASS

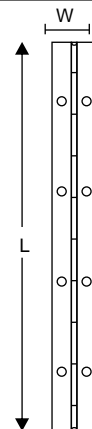

38 : STEEL BULLET HINGES



ITEM CODE	LENGTH	Outer dia	WT/PCS	Pcs In Inner	Pcs In Outer
MHIN3805010	50	10	0.030	50	1000
MHIN3807012	70	12	0.060	50	500
MHIN3807014	70	14	0.082	20	300
MHIN3807016	70	16	0.103	20	300
MHIN3807018	70	18	0.135	20	200
MHIN3807020	70	20	0.170	20	200
MHIN3810016	100	16	0.190	10	120
MHIN3810020	100	20	0.250	10	120
MHIN3810025	100	25	0.350	6	84
MHIN3810030	120	30	0.650	4	48

FINISH AVAILABLE - SC, ZP

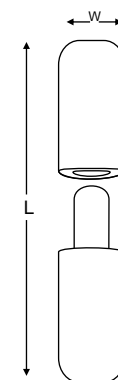

121A : LIGHT TEE HINGE UNCRANKED KNUCKLE, FIXED PIN



ITEM CODE	SIZE	LENGTH	WIDTH	THICKNESS	Screw No.	WT/Pair	Prs In Inner	Prs In Outer
MHIN0119075	3"	79	60	1.2	6	0.062	10	200
MHIN0119100	4"	104	67	1.2	6	0.089	10	200
MHIN0119150	6"	151	70	1.4	6	0.147	10	150
MHIN0119200	8"	201	80	1.4	6	0.171	10	100
MHIN0119225	9"	227	80	1.4	6	0.190	10	100
MHIN0119250	10"	253	80	1.4	6	0.220	10	80
MHIN0119300	12"	303	80	1.6	6	0.347	10	50
MHIN0119300	12"	303	89	1.6	6	0.356	10	50

FINISH AVAILABLE - SC, BZP, ARJUNA, YPZP, JAPD, EXB, DUROSIL
Note : Also available With Brass or Stainless Steel Pin.

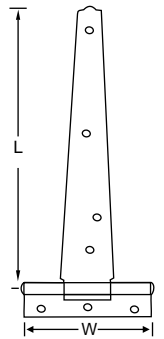

119P : LIGHT TEE PREMIUM UNCRANKED KNUCKLE, FIXED PIN



ITEM CODE	SIZE	LENGTH	WIDTH	THICKNESS	Screw No.	WT/Pair	Prs In Inner	Prs In Outer
MHINP119100	4"	100	66	1.6	6	0.100	10	200
MHINP119150	6"	153	70	1.6	6	0.165	10	120
MHINP119200	8"	200	80	1.6	6	0.230	10	80
MHINP119225	9"	231	76	1.6	6	0.260	10	80
MHINP119250	10"	248	76	1.6	6	0.284	10	60

FINISH AVAILABLE - SC, BZP, ARJUNA, JAPD, EXB, DUROSIL
Note : Also available With Brass or Stainless Steel Pin.

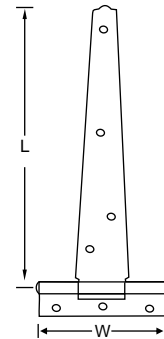

121M : MEDIUM TEE HINGE UNCRANKED KNUCKLE, FIXED PIN



ITEM CODE	SIZE	LENGTH	WIDTH	THICKNESS	Screw No.	WT/PAIR	Prs In Inner	Prs In Outer
MHIN0120250	10"	255	89	1.85	8	0.350	5	50
MHIN0120300	12"	305	100	1.85	8	0.455	5	40
MHIN0120350	14"	355	115	1.85	8	0.570	5	35
MHIN0120375	15"	380	115	1.85	8	0.610	5	30
MHIN0120400	16"	405	125	2.20	10	0.848	5	20
MHIN0120450	18"	455	130	2.20	10	0.928	5	20
MHIN0120500	20"	505	150	2.25	12	1.282	5	15
MHIN0120600	24"	605	150	2.25	12	1.455	5	10

FINISH AVAILABLE - SC, BZP, ARJUNA, YPZP, JAPD, EXB, HSG, DUROSIL
Note : Also available With Brass or Stainless Steel Pin.

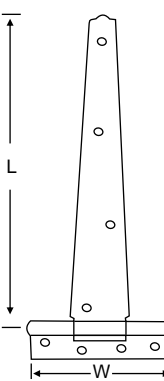

120P : PREMIUM MEDIUM TEE HINGE UNCRANKED KNUCKLE, FIXED PIN

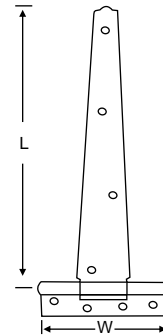

ITEM CODE	SIZE	LENGTH	WIDTH	THICKNESS	Screw No.	WT/PAIR	Prs In Inner	Prs In Outer
MHINP120300	12"	305	100	1.9	8	0.510	5	40
MHINP120350	14"	351	114	1.9	8	0.630	5	30
MHINP120375	15"	384	114	1.9	10	0.640	5	30
MHINP120400	16"	410	124	2.5	10	0.960	10	10
MHINP120450	18"	465	140	2.5	10	1.110	10	10

FINISH AVAILABLE - SC, BZP, ARJUNA, YPZP, JAPD, EXB, HSG, DUROSIL
 Note : Also available With Brass or Stainless Steel Pin.

119 : SCOTCH TEE HINGE UNCRANKED KNUCKLE, FIXED PIN

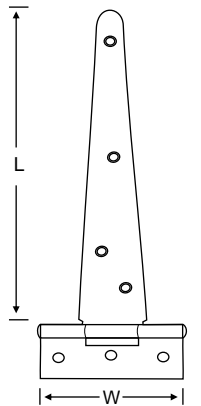

ITEM CODE	SIZE	LENGTH	WIDTH	THICKNESS	Screw No.	WT/PAIR	Prs In Inner	Prs In Outer
MHIN1119100	4"	100	83	2.5	10	0.320	5	50
MHIN1119150	6"	152	90	2.5	10	0.430	5	40
MHIN1119200	8"	200	102	3.0	10	0.660	5	30
MHIN1119250	10"	258	115	3.0	12	0.900	5	20
MHIN1119300	12"	303	126	3.0	12	1.100	5	5
MHIN1119350	14"	357	140	3.4	12	1.674	5	5
MHIN1119375	16"	406	145	3.4	12	1.720	5	5

FINISH AVAILABLE - SC, BZP, ARJUNA, YPZP, JAPD, EXB, HSG, DUROSIL
 Note : Also available With Brass or Stainless Steel Pin.

121H : HEAVY TEE HINGE UNCRANKED KNUCKLE, FIXED PIN

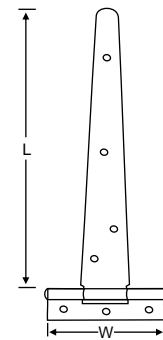

ITEM CODE	SIZE	LENGTH	WIDTH	THICKNESS	Screw No.	WT/PAIR	Prs In Inner	Prs In Outer
MHIN0122100	4"	102	90	2.4	9	0.384	5	50
MHIN0122150	6"	152	90	2.4	9	0.435	5	50
MHIN0122200	8"	200	100	2.4	9	0.512	5	40
MHIN0122250	10"	250	100	2.4	10	0.550	5	35
MHIN0122300	12"	303	100	2.5	10	0.660	5	30
MHIN0122350	14"	350	100	2.5	10	0.792	5	25
MHIN1120350	16"	408	140	2.5	10	1.140	5	15
MHIN1120250	18"	460	150	3.0	12	1.516	5	5
MHIN1120300	20"	510	165	3.0	12	1.800	5	5
MHIN1120350	24"	617	165	3.0	12	2.140	5	5

FINISH AVAILABLE - SC, BZP, ARJUNA, YPZP, JAPD, EXB, HSG, DUROSIL
 Note : Also available With Brass or Stainless Steel Pin.

868 : HEAVY SCOTCH TEE HINGE UNCRANKED KNUCKLE, FIXED PIN

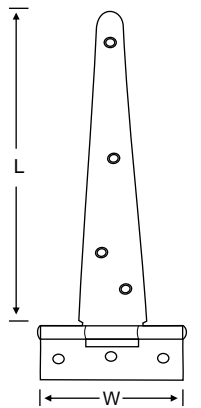

ITEM CODE	SIZE	LENGTH	WIDTH	THICKNESS	Screw No.	WT/PAIR	Prs In Inner	Prs In Outer
MHIN0868100	4"	102	90	2.5	9	0.396	5	50
MHIN0868150	6"	152	90	2.5	9	0.461	5	50
MHIN0868200	8"	200	100	2.5	9	0.521	5	40
MHIN0868250	10"	250	100	2.5	10	0.600	5	35
MHIN0868300	12"	303	100	2.8	10	0.720	5	25
MHIN0868350	14"	350	145	3.0	12	1.580	5	10
MHIN0868375	15"	382	145	3.0	12	1.600	2	10
MHIN0868400	16"	405	145	3.0	12	1.700	2	10
MHIN0868450	18"	455	177	3.15	12	2.100	2	10
MHIN0868500	20"	505	177	3.0	12	2.460	2	8
MHIN0868600	24"	610	177	3.0	12	2.800	2	6

FINISH AVAILABLE - SC, BZP, ARJUNA, YPZP, JAPD, EXB, HSG, DUROSIL,
 Note : Also available With Brass or Stainless Steel Pin

120 : STRONG TEE HINGE UNCRANKED KNUCKLE, FIXED PIN

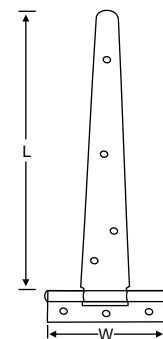

ITEM CODE	SIZE	LENGTH	WIDTH	THICKNESS	Screw No.	WT/PAIR	Prs In Inner	Prs In Outer
MHIN1120100	6"	155	89	2.0	8	0.312	5	50
MHIN1120150	8"	205	100	2.4	10	0.454	5	40
MHIN1120200	10"	255	102	2.4	10	0.510	5	35
MHIN1120250	12"	303	115	2.4	10	0.650	5	30
MHIN1120300	14"	356	128	2.4	10	0.880	5	20
MHIN1120350	16"	408	140	2.5	10	1.140	5	15
MHIN1120250	18"	460	150	3.0	12	1.516	5	5
MHIN1120300	20"	510	165	3.0	12	1.800	5	5
MHIN1120350	24"	617	165	3.0	12	2.140	5	5

FINISH AVAILABLE - SC, BZP, ARJUNA, YPZP, JAPD, EXB, HSG, DUROSIL
 Note : Also available With Brass or Stainless Steel Pin.

867 : EXTRA STRONG WEIGHTY TEE HINGE UNCRANKED KNUCKLE, FIXED PIN

ITEM CODE	SIZE	LENGTH	WIDTH	THICKNESS	Screw No.	WT/PAIR	Prs In Inner	Prs In Outer
MHIN0867100	4"	101	90	2.8	9	0.410	5	50
MHIN0867150	6"	150	90	2.8	9	0.500	5	40
MHIN0867200	8"	200	100	3.0	10	0.650	5	30
MHIN0867250	10"	250	115	3.0	10	0.794	5	25
MHIN0867300	12"	302	127	3.0	10	0.982	5	20

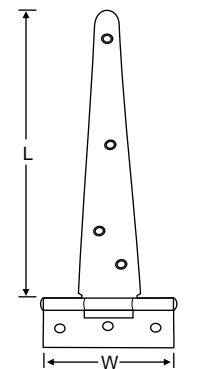
FINISH AVAILABLE - SC, BZP, ARJUNA, YPZP, JAPD, EXB, HSG, DUROSIL
 Note : Also available With Brass or Stainless Steel Pin.



910 : GRADED TEE HINGE



ITEM CODE	SIZE	LENGTH	WIDTH	THICKNESS	Screw No.	WT/Pair	Prs In Inner	Prs In Outer
MHIN0910100	4"	102	80	2.0	8	0.240	5	60
MHIN0910150	6"	150	90	2.20	8	0.340	5	40
MHIN0910225	9"	230	100	2.5	10	0.566	5	30
MHIN0910250	10"	250	100	2.5	10	0.589	5	30
MHIN0910300	12"	300	120	2.5	12	0.800	5	20
MHIN0910375	15"	375	140	3.0	12	1.348	5	5
MHIN0910450	18"	450	170	3.0	12	1.928	5	5
MHIN0910600	24"	600	200	3.0	12	3.087	2	2

FINISH AVAILABLE - SC, BZP, ARJUNA, YPZP, JAPD, EXB, HSG, DUROSIL
 Note : Also available With Brass or Stainless Steel Pin.

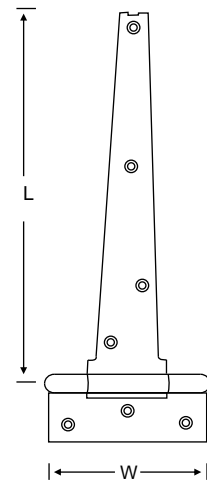

950H : STEEL STRAP HINGE UNCRANKED KNUCKLE (HEAVY WEIGHT)



ITEM CODE	SIZE	LENGTH	WIDTH	THICKNESS	Screw No.	WT/PAIR	Prs In Inner	Prs In Outer
MHIN9501100	4"	100	38	1.9	8	0.390	5	50
MHIN9501150	6"	150	58	2.65	8	0.548	5	40
MHIN9501200	8"	200	75	3.0	12	0.998	5	20

FINISH AVAILABLE - SC, BZP, ARJUNA, YPZP, JAPD, EXB, HSG, DUROSIL
 Note : Also available With Brass or Stainless Steel Pin.

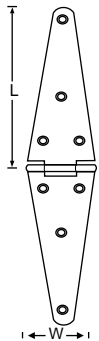

950 : STEEL STRAP HINGE UNCRANKED KNUCKLE



ITEM CODE	SIZE	LENGTH	WIDTH	THICKNESS	Screw No.	WT/PAIR	Prs In Inner	Prs In Outer
MHIN0950100	4"	102	35	1.5	6	0.121	10	150
MHIN0950150	6"	150	44	1.9	8	0.310	10	70
MHIN0950200	8"	205	44	2.0	8	0.402	5	50

FINISH AVAILABLE - SC, BZP, ARJUNA, YPZP, JAPD, EXB, HSG, DUROSIL
 Note : Also available With Brass or Stainless Steel Pin.

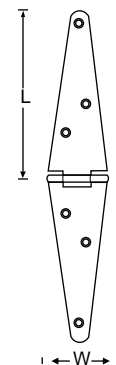

234 : GATE HOLD BACK HINGE / PENTURE DE GONDS (FRENCH SPECIFICATION)



ITEM CODE	SIZE	LENGTH	WIDTH	THICKNESS	Screw No.	WT/PAIR	Prs In Inner	Prs In Outer
MGFI0234300	12"	300	112	4.0	10	0.520	10	40
MGFI0234400	16"	400	112	4.0	10	0.620	10	30
MGFI0234500	20"	500	112	4.0	10	0.700	10	30
MGFI0234600	24"	600	112	4.0	10	0.800	5	25

FINISH AVAILABLE - SC, BZP, ARJUNA, EXB, JAPD, HSG, DUROSIL

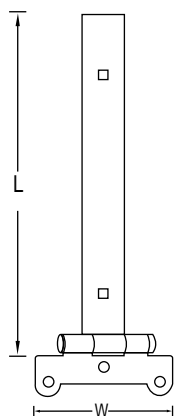

30 : STEEL STRAP HINGE UNCRANKED KNUCKLE (MEDIUM WEIGHT)



ITEM CODE	SIZE	LENGTH	WIDTH	THICKNESS	Screw No.	WT/PAIR	Prs In Inner	Prs In Outer
MHIN0030250	10"	259	63	2.6	10	0.985	5	20
MHIN0030300	12"	300	63	2.8	10	1.320	5	10

FINISH AVAILABLE - SC, BZP, ARJUNA, YPZP, JAPD, EXB, HSG, DUROSIL
 Note : Also available With Brass or Stainless Steel Pin.

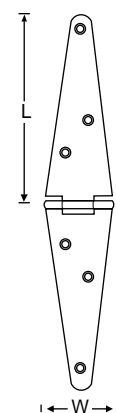

1055 : HOOK AND BAND HINGE (STRAIGHT)



ITEM CODE	SIZE	LENGTH	WIDTH	THICKNESS	Screw No.	WT/PAIR	Prs In Inner	Prs In Outer
MGFI1055250	10"	250	38	4	12	1.381	2	14
MGFI1055300	12"	300	38	4	12	1.454	2	12
MGFI1055350	14"	350	45	4	12	1.812	2	8
MGFI1055400	16"	400	45	4	12	1.892	2	8
MGFI1055450	18"	450	48	4.5	12	2.898	1	6
MGFI1055500	20"	500	48	4.5	12	3.036	1	6
MGFI1055600	24"	600	48	4.8	12	3.524	1	3
MGFI1055750	30"	750	57	5	12	5.270	1	3
MGFI1055900	36"	900	63	5	12	6.644	1	2
MGFI1055142	42"	1050	69	5	12	9.900	1	1
MGFI1055148	48"	1200	69	5	12	10.700	1	1

FINISH AVAILABLE - SC, BZP, ARJUNA, EXB, JAPD, HSG, DUROSIL

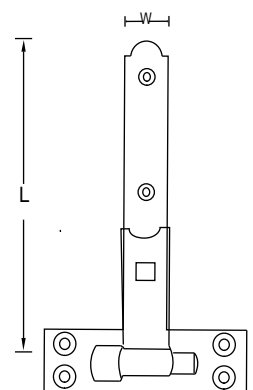

128 : PREMIUM HOOK AND BAND HINGE (STRAIGHT)



ITEM CODE	SIZE	LENGTH	WIDTH	THICKNESS	Screw No.	WT/PAIR	Prs In Inner	Prs In Outer
MGFI0128250	10"	255	38	4.8	12	1.475	5	5
MGFI0128300	12"	305	38	4.8	12	1.710	5	5
MGFI0128350	14"	357	38	4.8	12	1.800	5	5
MGFI0128400	16"	404	38	4.8	12	1.860	5	5
MGFI0128450	18"	460	50	4.8	12	3.160	2	2
MGFI0128500	20"	512	50	4.8	12	3.280	2	2
MGFI0128600	24"	610	56	4.8	12	4.580	2	2
MGFI0128750	30"	761	56	5.4	12	5.160	1	1
MGFI0128900	36"	915	56	5.4	12	6.300	1	1

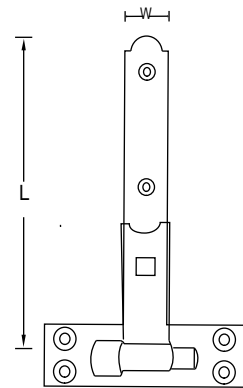

FINISH AVAILABLE - SC,BZP,ARJUNA, EXB,JAPD,HSG,DUROSIL

1056 : HOOK AND BAND HINGE (CRANKED)



ITEM CODE	SIZE	LENGTH	WIDTH	THICKNESS	Screw No.	WT/PAIR	Prs In Inner	Prs In Outer
MGFI1056250	10"	250	38	4	12	1.381	2	14
MGFI1056300	12"	300	38	4	12	1.454	2	12
MGFI1056350	14"	350	45	4	12	1.812	2	8
MGFI1056400	16"	400	45	4	12	1.892	2	8
MGFI1056450	18"	450	48	4.5	12	2.898	1	6
MGFI1056500	20"	500	48	4.5	12	3.036	1	6
MGFI1056600	24"	600	48	4.8	12	3.524	1	3
MGFI1056750	30"	750	57	5	12	5.270	1	3
MGFI1056900	36"	900	63	5	12	6.644	1	2
MGFI1055142	42"	1050	69	5	12	9.900	1	1
MGFI1055148	48"	1200	69	5	12	10.700	1	1

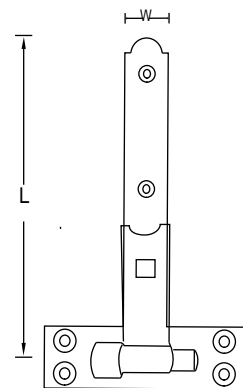

FINISH AVAILABLE - SC,BZP,ARJUNA, EXB,JAPD,HSG,DUROSIL

130 : PREMIUM HOOK AND BAND HINGE (CRANKED)



ITEM CODE	SIZE	LENGTH	WIDTH	THICKNESS	Screw No.	WT/PAIR	Prs In Inner	Prs In Outer
MGFI0130250	10"	255	38	4.8	12	1.475	5	5
MGFI0130300	12"	305	38	4.8	12	1.710	5	5
MGFI0130350	14"	357	38	4.8	12	1.800	5	5
MGFI0130400	16"	404	38	4.8	12	1.860	5	5
MGFI0130450	18"	460	50	4.8	12	3.160	2	2
MGFI0130500	20"	512	50	4.8	12	3.280	2	2
MGFI0130600	24"	610	56	4.8	12	4.580	2	2
MGFI0130750	30"	761	56	5.4	12	5.160	1	1
MGFI0130900	36"	915	56	5.4	12	6.300	1	1

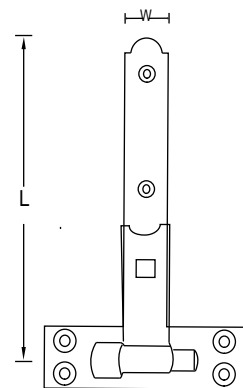

FINISH AVAILABLE - SC,BZP, ARJUNA,EXB,JAPD,HSG,DUROSIL

1055L : LIGHT HOOK AND BAND HINGE (STRAIGHT)



ITEM CODE	SIZE	LENGTH	BAND WIDTH	THICKNESS	SCREW No.	WT/PAIR	Prs In Inner	Prs In Outer
MGFI1053250	10"	250	38	3.0	10	1.100	2	14
MGFI1053300	12"	300	38	3.0	12	1.200	2	14
MGFI1053350	14"	350	45	3.0	12	1.550	2	10
MGFI1053400	16"	400	45	3.0	12	1.620	2	10

FINISH AVAILABLE - SC, BZP, ARJUNA, JAPD, EXB, HSG,DUROSIL

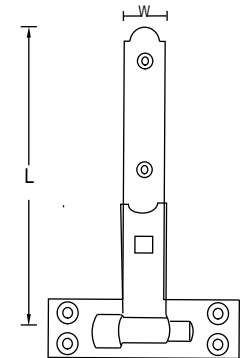

1056L : LIGHT HOOK AND BAND HINGE (CRANKED)



ITEM CODE	SIZE	LENGTH	BAND WIDTH	THICKNESS	SCREW No.	WT/PAIR	Prs In Inner	Prs In Outer
MGFI1054250	10"	250	38	3.0	10	1.100	2	14
MGFI1054300	12"	300	38	3.0	12	1.200	2	14
MGFI1054350	14"	350	45	3.0	12	1.550	2	10
MGFI1054400	16"	400	45	3.0	12	1.620	2	10

FINISH AVAILABLE - SC, BZP, ARJUNA, JAPD, EXB, HSG,DUROSIL

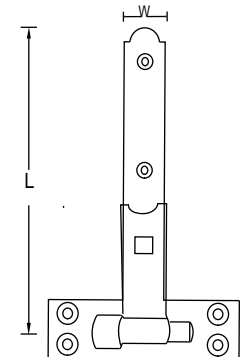

1057 : ADJUSTABLE HOOK AND BAND HINGE

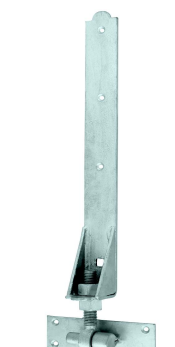

ITEM CODE	SIZE	LENGTH	BAND WIDTH	THICKNESS	Screw No.	WT/PAIR	Prs In Inner	Prs In Outer
MGFI1057300	12"	300	45	4.0	12	3.000	1	4
MGFI1057450	18"	450	50	4.5	12	4.400	1	4
MGFI1057600	24"	600	50	5.0	12	5.090	1	3
MGFI1057750	30"	750	57	5.0	12	6.834	1	2
MGFI1057900	36"	900	63	5.0	12	7.552	1	2

FINISH AVAILABLE - SC, BZP, ARJUNA,EXB, HSG,DUROSIL

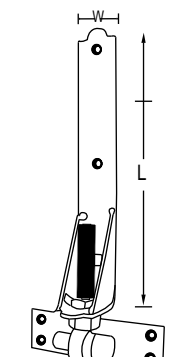

140 : HOOK ON BACK PLATE TO SUIT HOOK & BAND



ITEM CODE	SIZE	LENGTH	WIDTH	THICKNESS	PIN DIA	SCREW No.	WT/PAIR	Prs In Inner	Prs In Outer
MGF112GXXX	10" & 12"	134	38	4.0	12	12	0.522	5	30
MGF112GXXX	14" & 16"	134	45	4.0	13	12	0.572	5	30
MGF112GXXX	18" & 20" & 24"	166	48	4.5	16	12	0.920	5	20
MGF112GXXX	30" & 36"	200	57	5.0	19	12	1.556	2	10

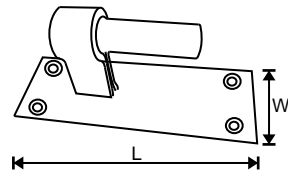

FINISH AVAILABLE - BZP, ARJUNA, EXB, HSG, DUROSIL

112G : HOOK ON BACK PLATE TO SUIT ADJ. BAND



ITEM CODE	SIZE	LENGTH	WIDTH	THICKNESS	SCREW No.	WT/PAIR	PIN DIA	Prs In Inner	Prs In Outer
MGF112GXXX	12", 14" & 16"	135	45	4.0	12	0.374	16	10	40
MGF112GXXX	18", 20" & 24"	166	50	5.0	12	0.462	16	10	40
MGF112GXXX	30" & 36"	200	62	5.0	12	0.542	19	10	30

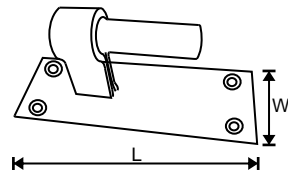

FINISH AVAILABLE - BZP, ARJUNA, EXB, HSG, DUROSIL

499 : STEEL REVERSIBLE HINGE WITH CAST IRON CUP



ITEM CODE	SIZE	LENGTH	WIDTH	THICKNESS	SCREW No.	WT/PAIR	PRS IN INNER	PRS IN OUTER
MGF10499250	10"	250	38	4.0	12	1.430	2	14
MGF10499300	12"	300	38	4.0	12	1.500	2	12
MGF10499350	14"	350	45	4.0	12	2.040	2	10
MGF10499400	16"	400	45	4.0	12	2.166	2	10
MGF10499450	18"	450	48	4.5	12	3.244	1	6
MGF10499500	20"	500	48	4.5	12	3.439	1	6
MGF10499600	24"	600	48	4.8	12	3.920	1	4
MGF10499750	30"	750	57	5.0	12	5.260	1	2
MGF10499900	36"	900	63	5.0	12	6.684	1	2

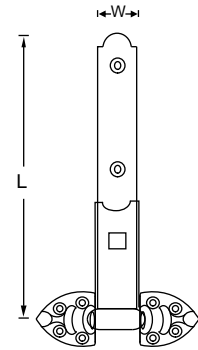

FINISH AVAILABLE - SC, BZP, ARJUNA, HSG, EXB, DUROSIL

499LW: STEEL LIGHT WEIGHT REVERSIBLE HINGE WITH CAST IRON CUP

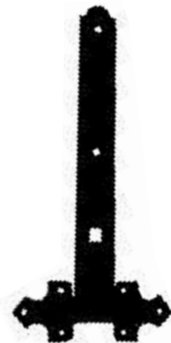

ITEM CODE	SIZE	LENGTH	WIDTH	THICKNESS	SCREW No.	WT/PAIR	PRS IN INNER BOX	PRS IN OUTER BOX
MGF10498300	12"	300	38	3.0	12	1.682	2	10
MGF10498350	14"	350	43	3.0	12	1.760	2	10
MGF10498400	16"	400	43	3.0	12	1.832	2	10
MGF10498450	18"	450	43	3.0	12	1.928	2	10
MGF10498500	20"	500	43	3.0	12	2.142	2	8
MGF10498600	24"	600	43	3.0	12	2.570	2	8

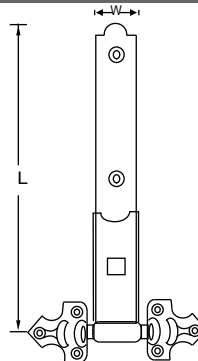

FINISH AVAILABLE - SC, BZP, ARJUNA, HSG, EXB, DUROSIL

499C : CUP ONLY FOR REVERSIBLE HINGE



ITEM CODE	SIZE	LENGTH	WIDTH	THICKNESS	HOLE DIA	SCREW No.	WT/Set	SET IN INNER BOX	SET IN OUTER BOX
MGF1499C016	10" & 12"	51	50	6.5-7.5	12	10	0.460	4	24
MGF1499C020	14" & 16"	54	53	6.5-7.5	14	10	0.632	4	24
MGF1499C022	18" & 20" & 24"	67	62	6.5-7.5	18	12	1.016	2	16
MGF1499C022	30" & 36"	67	62	7.5-8.5	20	12	1.080	2	16

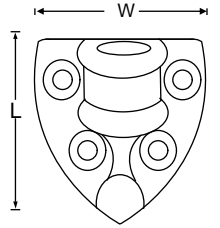

FINISH AVAILABLE - EXB, SC, HSG, DUROSIL

1056C/D : HOOK AND BAND (DECORATIVE SQUARE TAIL)



ITEM CODE	SIZE	LENGTH	WIDTH	THICKNESS	Screw No.	WT/PAIR	Prs In Inner	Prs In Outer
MGF11059250	10"	260	40	3.0	12	0.854	5	20
MGF11059300	12"	310	40	3.0	12	0.950	5	20
MGF11059375	16"	390	40	3.0	12	1.124	5	15
MGF11059500	20"	515	40	3.0	12	1.310	2	2
MGF11059600	24"	615	40	4.0	12	1.972	2	2
MGF11059750	30"	750	40	4.0	12	2.282	2	2

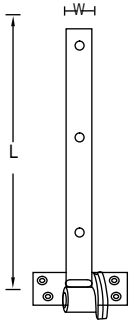

FINISH AVAILABLE - SC, BZP, HSG, ARJUNA, EXB, DUROSIL

(Also Available 1055D Decorative)

7182 : ESTATE PATTERN BAND



ITEM CODE	SIZE	LENGTH	WIDTH	THICKNESS	WT/PCS	Pcs In Inner	Pcs In Outer
MGF17182450	18"	450	57	5.0	1.270	4	12
MGF17182500	20"	500	57	5.0	1.382	4	12

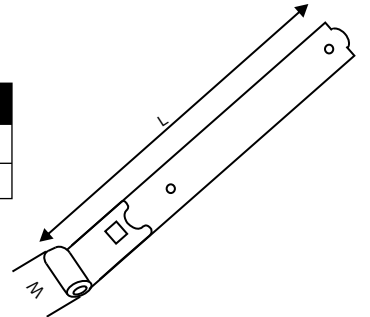

FINISH AVAILABLE - SC, BZP, ARJUNA, EXB, HSG, DUROSIL

1061 : SHORT HINGES



ITEM CODE	SIZE	LENGTH	WIDTH	THICKNESS	WT/PCS	Pcs In Inner	Pcs In Outer
MGF11061150	6"	151	40	8.0	0.518	10	30
MGF11061300	12"	308	40	8.0	0.908	10	20
MGF11061450	18"	460	40	8.0	1.211	4	16

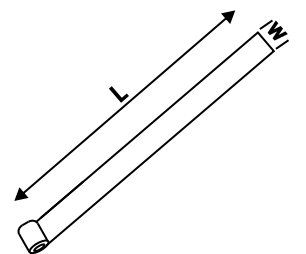

FINISH AVAILABLE - SC, BZP, ARJUNA, EXB, HSG, DUROSIL



GF0251 : BARREL HINGE



ITEM CODE	SIZE	LENGTH	WIDTH	DIA	BOLT	WT/SET	Set In Inner	Set In Outer
MHIN0251XXX	1"	36	29	9.4	M6	0.024	50	500

FINISH AVAILABLE - SC, BZP,ARJUNA, YPZP, EB

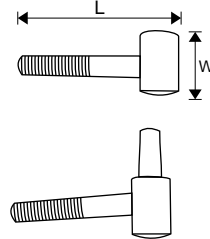

Cabinet Hinges

CABINET HINGE SPRUNG, 26 MM



GF111

CABINET HINGE UNSPRUNG, 26 MM



GF101

CABINET HINGE SPRUNG, 35 MM



GF112

CABINET HINGE UNSPRUNG, 35 MM



GF102

SURFACE MOUNT SPRUNG HINGE, 100MM



GF201

CABINET HINGE SPRUNG, 170 DEGREES

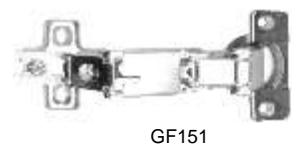

GF151

CLIP ON CABINET HINGE 35MM 90 DEGREES



GF115

CLIP ON CABINET HINGE SPRUNG, 170 DEGREES



GF155

SCREW No.	FINISH	PRS IN INNER	PRS IN OUTER
6	CHROME PLATED	5	100

551SSBB Stainless Steel two Ball Bearing Hinges
Certifire Certified CE 13 BSEN 1935

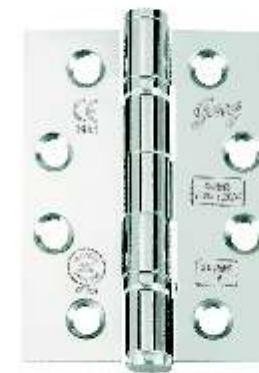

ITEM CODE	SIZE	LENGTH	WIDTH	THICKNESS	Screw No.	WT/PAIR	Prs In Inner	Prs In Outer
SHIN1001100	4"X3"	101	76	3.0	10	0.470	1	50
SHIN1002100	4"X3.5"	101	90	3.0	10	0.540	1	50
SHIN1003100	4"X4"	101	101	3.0	10	0.590	1	40
SHIN1005125	5"X3"	125	76	3.0	10	0.610	1	30
SHIN1006150	6"X3"	150	76	3.0	10	0.780	1	20

FINISH AVAILABLE - MIRROR POLISHED, ELECTRO BRASS, SATIN, BLACK NICKEL

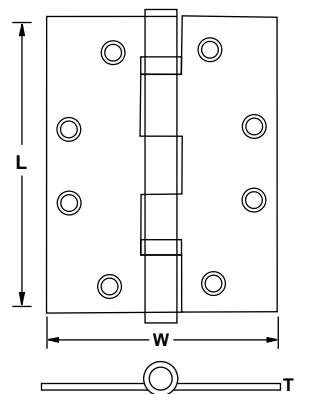

4 7 6 1* 1 4 0 13

* THIS EIGHT DIGIT CODING SYSTEM STANDS FOR



Digit 1
CATEGORY OF USE
4- Severe Duty

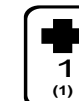

Digit 5
SAFETY
Single axis hinges are required to satisfy the essential requirements of safety in use. only grade 1 is identified.



Digit 2
DURABILITY
200,000 test cycles, heavy duty hinges on doors only.



Digit 6
CORROSION RESISTANCE
Grade 4 - 240 hrs. Neutral salt spray exposure.



Digit 3
TEST DOOR MASS
for load deformation - 240 kgs.

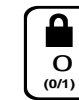

Digit 7
SECURITY
Suitable for applications requiring a degree of security.



Digit 4
SUITABILITY FOR FIRE/SMOKE
suitable for fire/smoke resistant door assemblies



Digit 8
HINGE GRADE
Grade 13 having Endurance Test - 120 kgs. 200,000 test cycles for usage on doors.

Anti Corrosive & Fire Tested

ANTI CORROSIVE 240 Hrs.

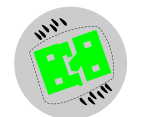

FIRE TESTED 1 Hr.



CF 714





551SSBB Stainless Steel two Ball Bearing Hinges

CE 11 BSEN 1935



ITEM CODE	SIZE	LENGTH	WIDTH	THICKNESS	Screw No.	WT/PAIR	Prs In Inner	Prs In Outer
SHIN1056075	3"X2"	75	50	2.0	8	0.20	1	100
SHIN1055075	3"X2"	75	50	2.2	8	0.21	1	100
SHIN1053100	4"X2.5"	100	67	2.0	8	0.31	1	40
SHIN1057100	4"X2.5"	100	67	2.5	10	0.38	1	40
SHIN1052100	4"X3"	100	76	2.0	8	0.33	1	40
SHIN1051100	4"X3"	100	76	3.0	10	0.47	1	40
SHIN1054100	5"X2.5"	125	67	2.5	10	0.42	1	30

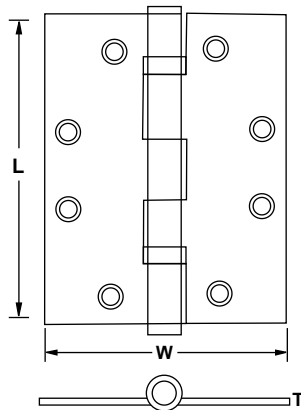

FINISH AVAILABLE - MIRROR, POLISHED, ELECTRO BRASS, SATIN, BLACK NICKEL

3	7	4	0	1	4	0	11
---	---	---	---	---	---	---	----

* THIS EIGHT DIGIT CODING SYSTEM STANDS FOR



Digit 1
CATEGORY OF USE
3- Heavy Duty

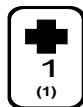

Digit 5
SAFETY
Single axis hinges are required to satisfy the essential requirements of safety in use. only grade 1is identified.



Digit 2
DURABILITY
200,000 test cycles, heavy duty hinges on doors only.



Digit 6
CORROSION RESISTANCE
Grade 4 - 240 hrs. Neutral salt spray exposure.



Digit 3
CATEGORY OF USE
4- Several Duty

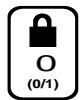

Digit 7
SECURITY
Suitable for applications requiring a degree of security.



Digit 4
SUITABILITY FOR FIRE/SMOKE
suitable for fire/smoke resistant door assemblies



Digit 8
HINGE GRADE
Grade 11 having Endurance Test - 80 kgs. 200,000 test cycles for usage on doors.

Anti Corrosive



ANTI CORROSIVE 240 Hrs.

CE 11 HINGES

551SSBB Stainless Steel two Ball Bearing Hinges

CE 7 BSEN 1935



ITEM CODE	SIZE	LENGTH	WIDTH	THICKNESS	Screw No.	WT/PRS	Prs In Inner	Prs In Outer
SHIN1106075	3"X2"	75	50	2.0	8	0.200	1	100
SHIN1105075	3"X2"	75	50	2.2	8	0.210	1	100
SHIN1103100	4"X2.5"	100	67	2.0	8	0.310	1	40
SHIN1107100	4"X2.5"	100	67	2.5	10	0.380	1	40
SHIN1108100	4"X3"	100	76	2.0	8	0.330	1	40
SHIN1101100	4"X3"	100	76	3.0	10	0.470	1	40
SHIN1104125	5"X2.5"	125	67	2.5	10	0.420	1	30

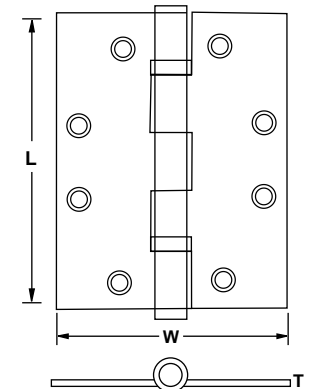

FINISH AVAILABLE - MIRROR, POLISHED, ELECTRO BRASS, SATIN, BLACK NICKEL

2	7	2	0	1	4	0	7
---	---	---	---	---	---	---	---

* THIS EIGHT DIGIT CODING SYSTEM STANDS FOR



Digit 1
CATEGORY OF USE
2- Medium Duty



Digit 5
SAFETY
Single axis hinges are required to satisfy the essential requirements of safety in use. only grade 1is identified.



Digit 2
DURABILITY
200,000 test cycles, heavy duty hinges on doors only.



Digit 6
CORROSION RESISTANCE
Grade 4 - 240 hrs. Neutral salt spray exposure.



Digit 3
TEST DOOR MASS
for load deformation - 40 kgs.

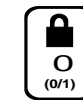

Digit 7
SECURITY
Suitable for applications requiring a degree of security.



Digit 4
SUITABILITY FOR FIRE/SMOKE
suitable for fire/smoke resistant door assemblies



Digit 8
HINGE GRADE
Grade 7 having Endurance Test - 40 kgs. 200,000 test cycles for usage on doors.

Anti Corrosive

ANTI CORROSIVE 240 Hrs.

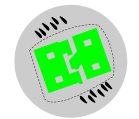

CE 7 HINGES

551BB(SSP/DSP) STAINLESS STEEL BALL BEARING HINGE (SINGLE / DOUBLE SECURITY PINS)



ITEM CODE	SIZE	LENGTH	WIDTH	THICKNESS	SCREW No	WT/PAIR	Prs In Inner	Prs In Outer
SHIN0556100	4"x4"	100	100	2.6	10	0.54	1	50
SHIN0557100	4"x3"	101	76	3.0	10	0.48	1	50

FINISH AVAILABLE - MIRROR, POLISHED, ELECTRO BRASS,
SATIN, BLACK NICKEL

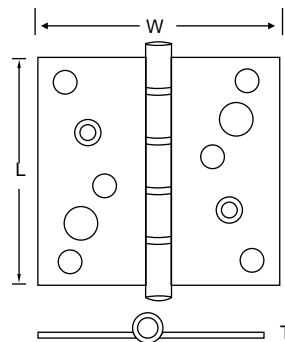

2451 : SICHERN BUTT HINGE



ITEM CODE	SIZE	LENGTH	WIDTH	THICKNESS	N.H.	Screw No	WT/PAIR	Prs In Inner	Prs In Outer
SHIN2451050	2"	50	36	1.4	4	6	0.056	1	240
SHIN2451065	2.5"	65	44	1.4	6	6	0.082	1	200
SHIN2451075	3"	75	49	1.4	6	7	0.111	1	160
SHIN2451090	3.5"	90	56	1.75	6	8	0.190	1	80
SHIN24510100	4"	100	71	1.75	8	8	0.260	1	60

FINISH AVAILABLE - MIRROR, POLISHED, ELECTRO BRASS, SATIN, BLACK NICKEL

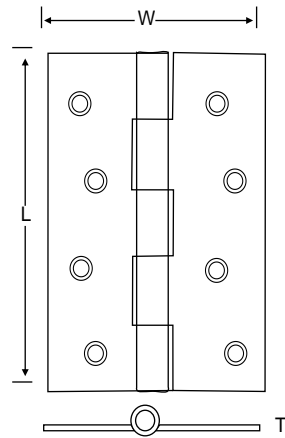

CONCEALED HINGE (GZC)



SIZE AVAILABLE : WIDTH x HEIGHT

- 12.4 x 43.7
- 12.7 x 60.4
- 15.7 x 68.8
- 18.4 x 94
- 24.7 x 115.8
- 27.8 x 116
- 33.6 x 137.2

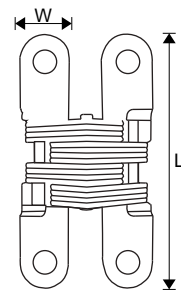

453 : STAINLESS STEEL BUTT HINGE STANDARD CRANKED KNUCKLE, FIXED PIN



ITEM CODE	SIZE	LENGTH	WIDTH	THICKNESS	SCREW No	WT/PAIR	Prs In Inner	Prs In Outer
SHIN0453075	3"	75	49	1.5	7	0.124	10	200
SHIN0453100	4"	101	71	1.8	8	0.267	5	100

FINISH AVAILABLE - MIRROR, POLISHED, ELECTRO BRASS, SATIN, BLACK NICKEL
ALSO AVAILABLE WITH BUTTON TIP PIN,

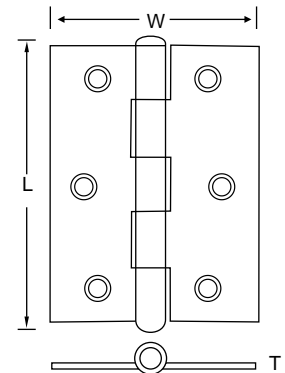

451SS : STAINLESS STEEL STRONG BUTT HINGES CRANKED KNUCKLE, FIXED PIN



ITEM CODE	SIZE	LENGTH	WIDTH	THICKNESS	Screw No.	WT/PAIR	Prs In Inner	Prs In Outer
SHIN0451050	2"	50	42	2.5	8	0.115	10	200
SHIN0451075	3"	76	64	2.5	10	0.270	10	80
SHIN0451100	4"	101	75	2.6	10	0.420	5	50

FINISH AVAILABLE - MIRROR, POLISHED, ELECTRO BRASS,
SATIN, BLACK NICKEL
Also Available in rounded corner Code 451 RC,

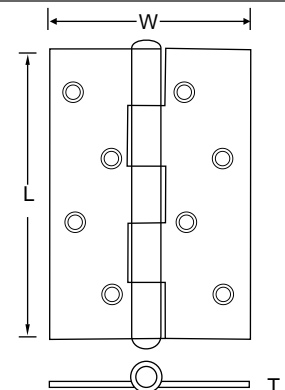

551W : STAINLESS STEEL BUTT HINGE (HEAVY DUTY) CRANKED KNUCKLE DOUBLEWASHERED WITH SPUN OR BUTTON TIP PIN



ITEM CODE	SIZE	LENGTH	WIDTH	THICKNESS	SCREW No	WT/PAIR	Prs In Inner	Prs In Outer
SHIN0563100	4"	101	76	2.6	10	0.416	5	50
SHIN0563100	4"	101	76	2.9	12	0.500	5	50
SHIN0563100	4"	101	90	2.6	10	0.480	5	50
SHIN0563100	4"	101	101	2.6	12	0.530	5	40

FINISH AVAILABLE - MIRROR, POLISHED, ELECTRO BRASS, SATIN, BLACK NICKEL
ALSO AVAILABLE SINGLE WASHER HINGE & BUTTON TIP PIN

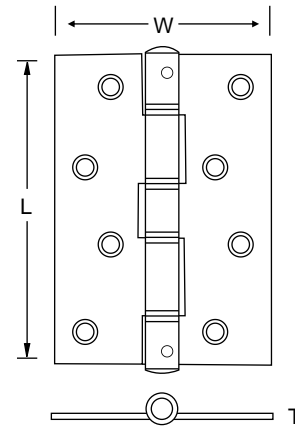

459SS : STAINLESS STEEL SUPPORTING HINGES KNUCKLE, HANDED



ITEM CODE	SIZE	LENGTH	WIDTH	THICKNESS	SCREW No	WT/PAIR	Prs In Inner	Prs In Outer
SHIN459L100	4"	100	86	3.0	10	0.314	10	100

FINISH AVAILABLE - MIRROR, POLISHED, ELECTRO BRASS, SATIN, BLACK NICKEL
AVAILABLE : R/H & L/H

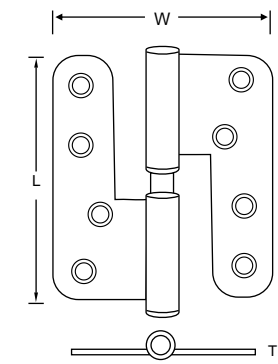

466SS : STAINLESS STEEL RISING BUTT HINGES HANDED CRANKED KNUCKLE, LIFT - OFF PATTERN, FLUSH PIN

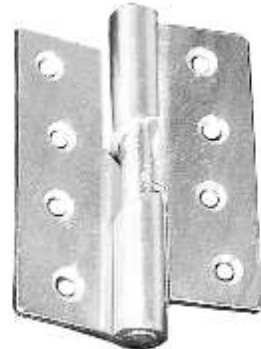

ITEM CODE	SIZE	LENGTH	WIDTH	THICKNESS	SCREW No	WT/PAIR	Prs In Inner	Prs In Outer
SHIN0466075	3"	76	70	2.55	8	0.327	5	80
SHIN0466100	4"	100	80	3.0	10	0.551	5	50

FINISH AVAILABLE - MIRROR, POLISHED, ELECTRO BRASS,
SATIN, BLACK NICKEL
AVAILABLE : R/H & L/H

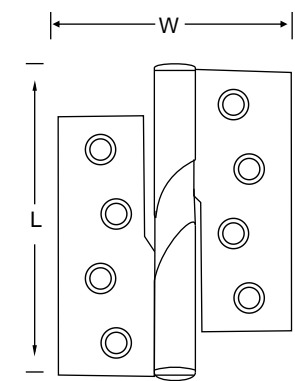

458SSRC : STAINLESS STEEL RADIUS CORNER HINGES HANDED- CRANKED KNUCKLE, LIFT - OFF



ITEM CODE	SIZE	LENGTH	WIDTH	THICKNESS	SCREW No	WT/PAIR	Prs In Inner	Prs In Outer
SHIN0458080	3"	80	80	2.5	7	0.315	5	80

FINISH AVAILABLE - MIRROR, POLISHED, ELECTRO BRASS, SATIN, BLACK NICKEL
AVAILABLE : R/H & L/H

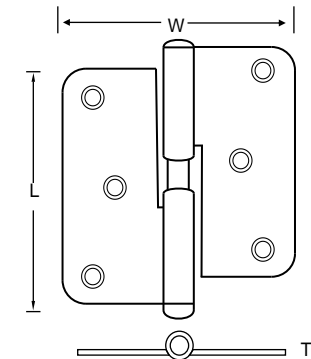

105SSBB : STAINLESS STEEL FLUSH HINGES KNUCKLE, TWO BALL BEARING AND BUTTON TIP PIN



ITEM CODE	SIZE	LENGTH	WIDTH	THICKNESS	SCREW No	WT/PAIR	Prs In Inner	Prs In Outer
SHIN0105101	4"	101	72	2.5	8	0.314	10	100

FINISH AVAILABLE - MIRROR, POLISHED, ELECTRO BRASS
SATIN, BLACK NICKEL

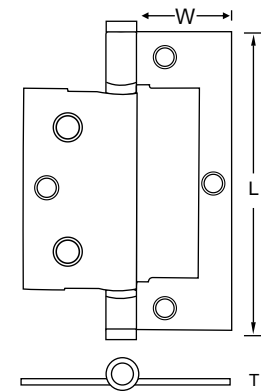

3210SS STAINLESS STEEL PARLIAMENT HINGE



ITEM CODE	SIZE	LENGTH	SIZE WIDTH	OPEN WIDTH	THICKNESS	SCREW No	WT/PAIR	Prs In Inner	Prs In Outer
SHIN3210075	4"x3"	100	76	122	2.5	6	0.546	2	30
SHIN3210100	4"x4"	100	102	158	2.5	10	0.628	2	30
SHIN3210125	4"x5"	100	125	185	2.5	10	0.704	2	20
SHIN3210150	4"x6"	100	150	205	2.5	10	0.770	1	20
SHIN3210200	4"x8"	100	200	270	2.5	10	0.974	1	20

FINISH AVAILABLE - MIRROR, POLISHED, ELECTRO BRASS,
SATIN, BLACK NICKEL

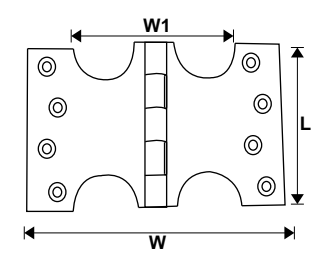

BRASS EXTRUDED BUTT HINGES



DPG CODE	SIZE	ITEM CODE	LENGTH	WIDTH	THICKNESS	Screw No.	WT/PAIR	Prs In Inner	Prs In Outer
GB1200	1"	BHIN1200025	25	19	1.4	4	0.015	10	1000
GB1200	1.5"	BHIN1200038	38	22	1.4	4	0.024	10	600
GB1200	2"	BHIN1200050	50	29	1.4	4	0.044	10	400
GB1200	2.5"	BHIN1200063	64	35	1.4	4	0.070	10	300
GB1200	3"	BHIN1200075	75	40	1.5	6	0.096	10	160
GB1200	4"	BHIN1200100	100	60	2.0	7	0.216	5	75
GB1203	5"	BHIN1200125	125	100	3.0	8	0.710	5	25

FINISH AVAILABLE - S/C, POLISHED & LACQUERED BRASS/CP/SNP



DPG CODE	SIZE	ITEM CODE	LENGTH	WIDTH	THICKNESS	Screw No.	WT/PAIR	Prs In Inner	Prs In Outer
GB1200	2"	BHIN1205050	50	32	1.4	4	0.052	10	300
GB1200	3"	BHIN1206075	75	40	1.65	6	0.104	10	100
GB1200	4"	BHIN1209100	100	66	2.0	8	0.267	5	75

FINISH AVAILABLE - S/C, POLISHED & LACQUERED BRASS/CP/SNP



DPG CODE	SIZE	ITEM CODE	LENGTH	WIDTH	THICKNESS	Screw No.	WT/PAIR	Prs In Inner	Prs In Outer
GB1200	3"	BHIN1207075	75	40	2.0	7	0.120	10	100
GB1201	4"	BHIN1201100	100	75	2.5	8	0.364	5	50

FINISH AVAILABLE - S/C, POLISHED & LACQUERED BRASS/CP/SNP



DPG CODE	SIZE	ITEM CODE	LENGTH	WIDTH	THICKNESS	Screw No.	WT/PAIR	Prs In Inner	Prs In Outer
GB1208	3"	BHIN1208075	75	50	2.0	7	0.156	10	75
GB1210	4"	BHIN1210100	100	75	3.0	8	0.440	5	40

FINISH AVAILABLE - S/C, POLISHED & LACQUERED BRASS/CP/SNP

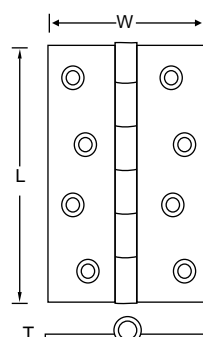
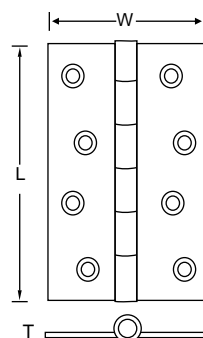
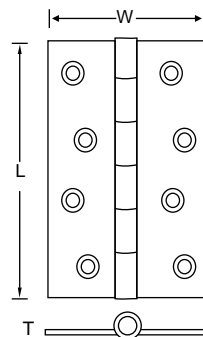
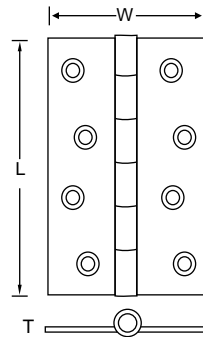

BRASS BUTT HINGES, WITH DOUBLE STEEL WASHERS (DSW)



DPG CODE	SIZE	ITEM CODE	LENGTH	WIDTH	THICKNESS	SCREW NO.	WT/PAIR	Prs In Inner	Prs In Outer
GB1300	3"	BHIN1300075	76	50	2.0	7	0.160	10	100
GB1300	4"	BHIN1300100	100	67	2.0	8	0.270	5	60

FINISH AVAILABLE - S/C, POLISHED & LACQUERED BRASS/CP/SNP



DPG CODE	SIZE	ITEM CODE	LENGTH	WIDTH	THICKNESS	SCREW NO.	WT/PAIR	Prs In Inner	Prs In Outer
GB1300	4"	BHIN1300100	100	67	3.0	8	0.360	5	40
GB1301	3"	BHIN1301075	75	50	2.5	8	0.190	10	200

FINISH AVAILABLE - S/C, POLISHED & LACQUERED BRASS/CP/SNP



DPG CODE	SIZE	ITEM CODE	LENGTH	WIDTH	THICKNESS	SCREW NO.	WT/PAIR	Prs In Inner	Prs In Outer
GB1311	4"	BHIN1311100	100	67	3.5	10	0.454	5	25
GB1303	4"	BHIN1303100	100	75	4.0	10	0.540	5	25

FINISH AVAILABLE - S/C, POLISHED & LACQUERED BRASS/CP/SNP



DPG CODE	SIZE	ITEM CODE	LENGTH	WIDTH	THICKNESS	SCREW NO.	WT/PAIR	Prs In Inner	Prs In Outer
GB1302	4"	BHIN1302100	100	75	3.0	8	0.440	5	80
GB1304	5"	BHIN1304125	125	75	3.0	8	0.530	5	40

FINISH AVAILABLE - S/C, POLISHED & LACQUERED BRASS/CP/SNP



DPG CODE	SIZE	ITEM CODE	LENGTH	WIDTH	THICKNESS	SCREW NO.	WT/PAIR	Prs In Inner	Prs In Outer
GB1305	5"	BHIN1305125	125	75	2.5	8	0.430	5	40

FINISH AVAILABLE - S/C, POLISHED & LACQUERED BRASS/CP/SNP

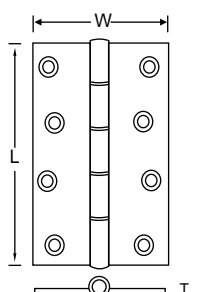
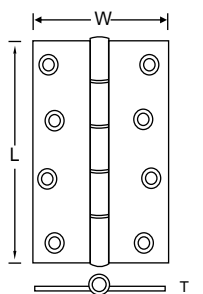
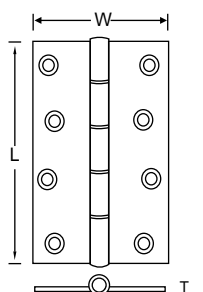
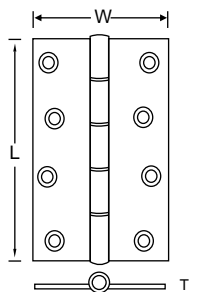
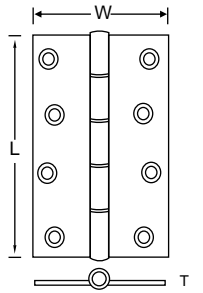

DPBW BRASS HINGE



DPG CODE	SIZE	ITEM CODE	LENGTH	WIDTH	THICKNESS	SCREW NO.	WT/PAIR	Prs In Inner	Prs In Outer
GB1350DPBW	3"	BHIN1350075	76	51	2.5	8	0.192	10	100
GB1350DPBW	4"	BHIN1350100	101	67	3.5	10	0.444	5	10

FINISH AVAILABLE - S/C, POLISHED & LACQUERED BRASS/CP/SNP

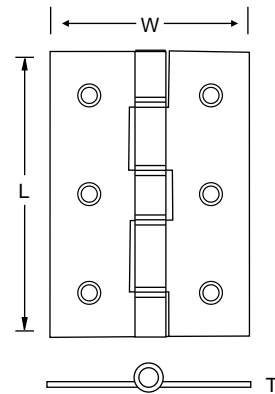

BRASS BUTT HINGES WITH TWO/FOUR BALL BEARING AND BUTTON TIP HEAD(S.S. PIN)



DPG CODE	SIZE	ITEM CODE	LENGTH	WIDTH	THICKNESS	SCREW No.	WT/PAIR	Prs In Inner	Prs In Outer
GB1401	3"	BHIN1401075	75	65	3.0	10	0.340	5	50
GB1402	4"	BHIN1402100	100	75	2.5	8	0.390	5	50
GB1406	5"	BHIN1406125	125	90	5.0	10	1.200	5	15

FINISH AVAILABLE -S/C, POLISHED & LACQUERED BRASS/CP/SNP

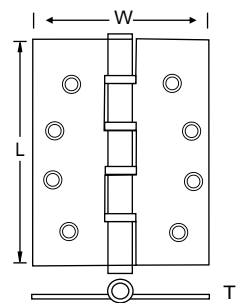

DPG CODE	SIZE	ITEM CODE	LENGTH	WIDTH	THICKNESS	SCREW NO.	WT/PAIR	Prs In Inner	Prs In Outer
GB1403	4"	BHIN1403100	100	90	2.5	10	0.520	5	40

FINISH AVAILABLE - S/C, POLISHED & LACQUERED BRASS/CP/SNP

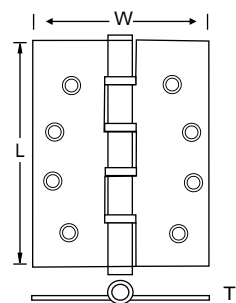

DPG CODE	SIZE	ITEM CODE	LENGTH	WIDTH	THICKNESS	SCREW NO.	WT/PAIR	Prs In Inner	Prs In Outer
GB1404	4"	BHIN1404100	100	75	3.0	10	0.560	5	25

FINISH AVAILABLE - S/C, POLISHED & LACQUERED BRASS/CP/SNP

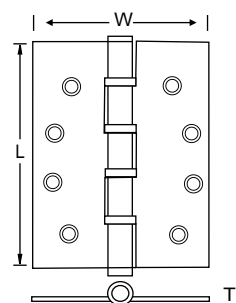

BRASS BUTT HINGES WITH TWO/FOUR BALL BEARING AND BUTTON TIP HEAD(S.S. PIN)



DPG CODE	SIZE	ITEM CODE	LENGTH	WIDTH	THICKNESS	SCREW NO.	WT/PAIR	Prs In Inner	Prs In Outer
GB1405	4"	BHIN1405100	100	100	3.0	10	0.770	5	25

FINISH AVAILABLE - S/C, POLISHED & LACQUERED BRASS/CP/SNP

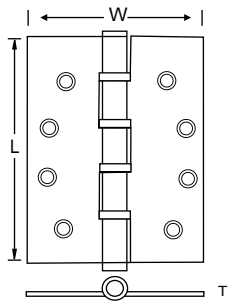

BRASS SQUARE BUTT HINGES



DPG CODE	SIZE	ITEM CODE	LENGTH	WIDTH	THICKNESS	SCREW NO.	WT/PAIR	Prs In Inner	Prs In Outer
GB1351	1.5"	BHIN1351040	38	38	1.5	4	0.052	10	200
GB1352	2"	BHIN1352050	50	50	1.5	4	0.092	10	160
GB1353	2.5"	BHIN1353065	63	63	1.8	6	0.164	10	100
GB1354	3.5"	BHIN1354090	87	87	2.0	6	0.340	5	50
GB1355	4"	BHIN1355100	100	100	3.0	8	0.600	2	30

FINISH AVAILABLE -S/C, POLISHED & LACQUERED BRASS/CP/SNP

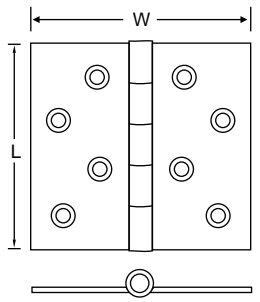

BRASS SQUARE BUTT HINGES WITH DOME HEAD PIN



DPG CODE	SIZE	ITEM CODE	LENGTH	WIDTH	THICKNESS	SCREW No.	WT/PAIR	Prs In Inner	Prs In Outer
GB1500	1.5"	BHIN1500040	38	38	1.5	4	0.060	10	200
GB1500	2"	BHIN1500050	50	50	1.6	6	0.103	10	160
GB1500	2.5"	BHIN1500065	63	63	2.0	8	0.180	10	100
GB1500	3.5"	BHIN1500090	89	89	2.2	8	0.360	5	50
GB1500	4"	BHIN1500100	100	100	3.0	10	0.620	2	30

FINISH AVAILABLE - S/C, POLISHED & LACQUERED BRASS/CP/SNP

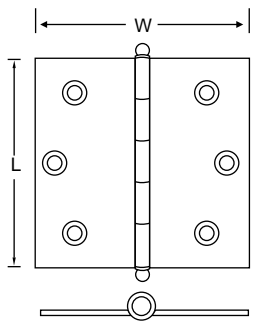

BRASS BUTT HINGES WITHOUT BALL BEARING AND TOMB HEAD (S.S. PIN)



DPG CODE	SIZE	ITEM CODE	LENGTH	WIDTH	THICKNESS	SCREW No.	WT/PAIR	Prs In Inner	Prs In Outer
GB1501	3.5"	BHIN1501090	90	90	2.5	7	0.460	5	40
GB1502	4"	BHIN1502100	100	90	2.5	7	0.540	5	40

FINISH AVAILABLE -S/C, POLISHED & LACQUERED BRASS/CP/SNP

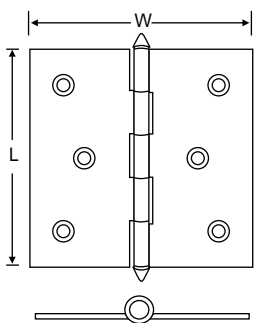

BRASS BUTT HINGES WITH TWO BALL BEARING AND FINIAL HEAD (S.S. PIN)



DPG CODE	SIZE	ITEM CODE	LENGTH	WIDTH	THICKNESS	SCREW No.	WT/PAIR	Prs In Inner	Prs In Outer
GB1601	4"	BHIN1601100	100	75	3.0	8	0.540	5	40
GB1602	4"	BHIN1602100	100	90	3.0	8	0.620	5	30

FINISH AVAILABLE - S/C,POLISHED & LACQUERED BRASS/CP/SNP

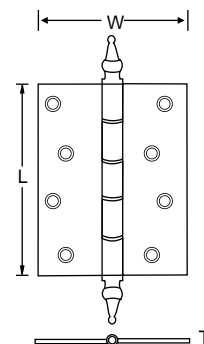

BRASS REFLECT HINGES WITH FLAT FLUSH / ROUND HEAD (S.S. PIN)



DPG CODE	SIZE	ITEM CODE	LENGTH	WIDTH	THICKNESS	SCREW No.	WT/PAIR	Prs In Inner	Prs In Outer
GB1901	2.5"	BHIN1901065	65	48	2.0	7	0.150	10	100
GB1902	3"	BHIN1902075	75	50	2.0	7	0.180	10	100
GB1903	3.5"	BHIN1903090	90	55	2.8	8	0.310	5	50

FINISH AVAILABLE - S/C,POLISHED & LACQUERED BRASS/CP/SNP

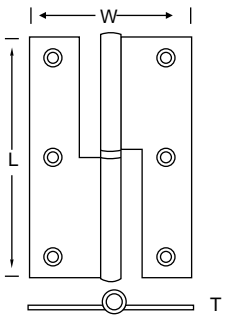

BRASS HINGES WITH ACRON TIP (S.S. PIN)



DPG CODE	SIZE	ITEM CODE	LENGTH	WIDTH	THICKNESS	SCREW No.	WT/PAIR	Prs In Inner	Prs In Outer
GB2201	3"	BHIN2201080	80	60	2.5	6	0.270	5	60

FINISH AVAILABLE - S/C,POLISHED & LACQUERED BRASS/CP/SNP

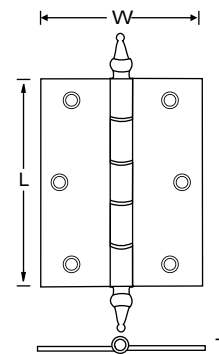

BRASS " H " HINGES WITH ROUND HEAD



DPG CODE	SIZE	ITEM CODE	LENGTH	SCREW No.	WT/PAIR	Prs In Inner	Prs In Outer
GB2098	2"	BHIN2098050	50	6	0.040	10	500
GB2099	2.5"	BHIN2099065	65	6	0.060	10	250
GB2100	3"	BHIN2100075	75	6	0.070	10	250
GB2101	3.5"	BHIN2100090	90	6	0.080	10	200

FINISH AVAILABLE - S/C,POLISHED & LACQUERED BRASS/CP/SNP

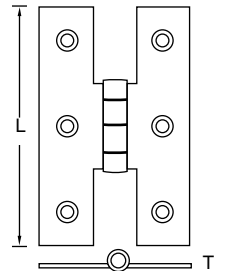

BRASS BUTT HINGES WITH TWO BALL BEARING AND DOUBLE SECURITY PIN



DPG CODE	SIZE	ITEM CODE	LENGTH	WIDTH	THICKNESS	SCREW No.	WT/PAIR	Prs In Inner	Prs In Outer
GB1701	3.5"	BHIN1701090	90	90	2.8	8	0.540	5	40

FINISH AVAILABLE - S/C,POLISHED & LACQUERED BRASS/CP/SNP

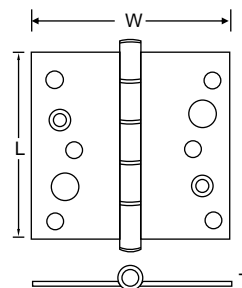

BRASS HINGES WITH RADIUS CORNER, ROUND HEAD



DPG CODE	SIZE	ITEM CODE	LENGTH	WIDTH	THICKNESS	SCREW No.	WT/PAIR	Prs In Inner	Prs In Outer
GB2302	3"	BHIN2302080	80	80	3.0	6	0.450	5	40

FINISH AVAILABLE - S/C,POLISHED & LACQUERED BRASS/CP/SNP

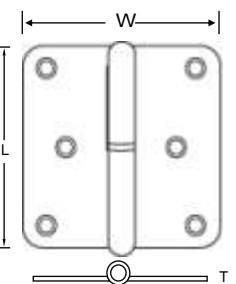

BRASS REFLECT HINGES (HANDED) (S.S. PIN)

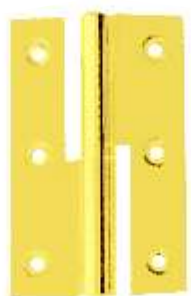

DPG CODE	SIZE	ITEM CODE	LENGTH	WIDTH	THICKNESS	SCREW No.	WT/PAIR	Prs In Inner	Prs In Outer
GB1801	4"	BHIN1801100	100	70	3.0	8	0.450	5	40

FINISH AVAILABLE - S/C,POLISHED & LACQUERED BRASS/CP/SNP

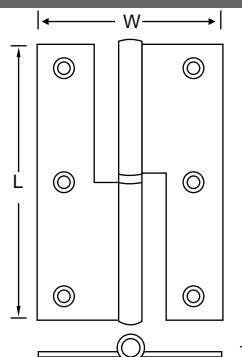

BRASS CRANKED HINGES WITH TWO BALL BEARING, BUTTON TIP HEAD (S.S. PIN)



DPG CODE	SIZE	ITEM CODE	LENGTH	WIDTH	THICKNESS	SCREW No.	WT/PAIR	Prs In Inner	Prs In Outer
GB2400	2.5"	BHIN2400063	63	58	1.7	8	0.195	10	100
GB2401	4"	BHIN2401100	100	80	3.0	8	0.660	5	60

FINISH AVAILABLE - S/C,POLISHED & LACQUERED BRASS/CP/SNP
NOTE : 2.5" IS WITHOUT BALL BEARING

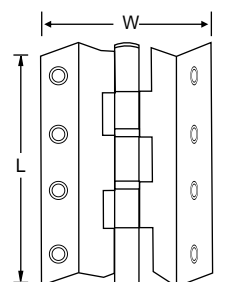



BRASS COUNTER HINGE

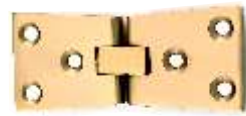

DPG CODE	SIZE	ITEM CODE	LENGTH	WIDTH	SCREW No.	WT/PAIR	Prs In Inner	Prs In Outer
GB3151	1"	BHIN3151025	25	77	7	0.140	10	100
GB3152	1.5"	BHIN3151032	32	100	7	0.230	5	80

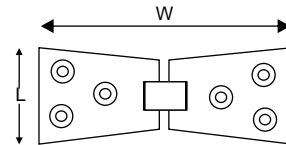

FINISH AVAILABLE - S/C,POLISHED & LACQUERED BRASS/CP/SNP

BRASS REFLUX HINGE



DPG CODE	SIZE	ITEM CODE	LENGTH	SCREW No.	WT/SET	Set In Inner	Set In Outer
GB1811	2.5"	BHIN1811065	65	6	0.065	10	200

FINISH AVAILABLE - S/C,POLISHED & LACQUERED BRASS/CP/SNP

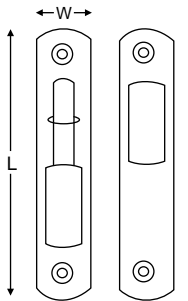

BRASS PARLIAMENT HINGES



DPG CODE	SIZE	ITEM CODE	LENGTH	WIDTH	THICKNESS	SCREW No.	WT/PAIR	Prs In Inner	Prs In Outer
GB3210	4"X2"	BHIN3210050	100x50	100	3.0	10	0.460	5	25
GB3210	4"X3"	BHIN3210075	100x75	125	3.0	10	0.600	5	20
GB3210	4"X4"	BHIN3210100	100x100	150	3.0	10	0.726	2	12
GB3210	4"X5"	BHIN3210125	100x125	175	3.0	10	0.834	2	12
GB3210	4"X6"	BHIN3210150	100x150	200	3.0	10	0.900	2	12

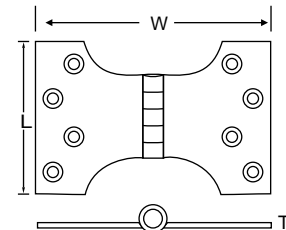

FINISH AVAILABLE - S/C,POLISHED & LACQUERED BRASS/CP/SNP

BRASS SNAKE HINGE



DPG CODE	SIZE	ITEM CODE	LENGTH	WIDTH	THICKNESS	SCREW No.	WT/PAIR	Prs In Inner	Prs In Outer
GB2451	2.5"	BHIN2451063	65	50	3.0	6	0.095	10	200

FINISH AVAILABLE - S/C,POLISHED & LACQUERED BRASS,ANTIQUE BRASS,CP/SNP

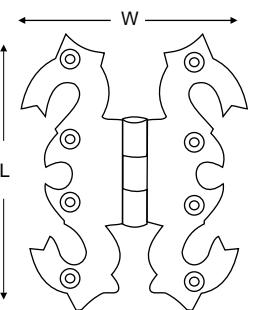

BRASS PARLIAMENT HINGES



DPG CODE	SIZE	ITEM CODE	LENGTH	WIDTH	THICKNESS	SCREW No.	WT/PAIR	Prs In Inner	Prs In Outer
GB3210A	4"X2"	BHIN3211050	100x50	100	4.0	10	0.575	4	20
GB3210A	4"X3"	BHIN3211075	100x75	125	4.0	10	0.800	4	16
GB3210A	4"X4"	BHIN3211100	100x100	150	4.0	10	0.968	4	4
GB3210A	4"X5"	BHIN3211125	100x125	175	4.0	10	1.112	4	4
GB3210A	4"X5"	BHIN3211150	100x150	200	4.0	10	1.184	4	4

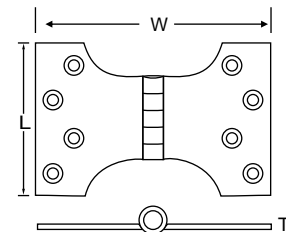

FINISH AVAILABLE - S/C,POLISHED & LACQUERED BRASS/CP/SNP

G1302 : BLACK ANTIQUE BUTTER FLY HINGE



ITEM CODE	SIZE	LENGTH	WIDTH	SCREW NO.	WT/PCS	Pcs In Inner	Pcs In Outer
CHIN1302070	3"	70	46	5	0.053	20	320

Finish Available - EXB

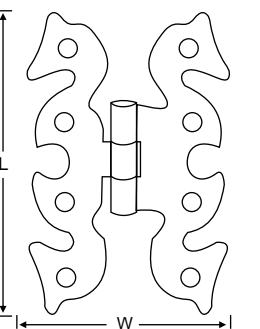

BRASS CONTINUOUS PIANO HINGES UNCRANKED KNUCKLE, FLUSH PIN



DPG CODE	SIZE	ITEM CODE	LENGTH	WIDTH	THICKNESS	PCS IN INNER	PCS IN OUTER
GB0101	UP TO 7"	BHIN0101XXX	Up to 2000	25,32,50	0.6	10	50

FINISH AVAILABLE - S/C,POLISHED & LACQUERED BRASS/CP/SNP

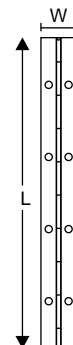

G0206 : BLACK ANTIQUE UNEQUAL HINGE



ITEM CODE	SIZE	LENGTH	WIDTH	SCREW NO.	WT/PCS	Pcs In Inner	Pcs In Outer
CHIN0206100	3.5"	105	86	7	0.160	10	100

Finish Available - EXB

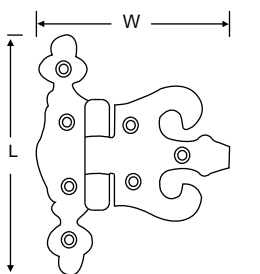

G0017 : BLACK ANTIQUE LIGHT DUTY HINGE



ITEM CODE	SIZE	LENGTH	WIDTH	SCREW NO.	WT/PCS	Pcs In Inner	Pcs In Outer
CHIN0017220	8"	200	106	8	0.203	10	80
CHIN0019290	12"	270	112	8	0.264	10	60

Finish Available - EXB

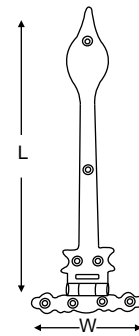

G0201 :



ITEM CODE	SIZE	LENGTH	WIDTH	SCREW NO.	WT/PCS	Pcs In Inner	Pcs In Outer
CHIN0201150	6"	145	90	7	0.158	10	80
CHIN0202225	9"	213	105	7	0.231	10	80

Finish Available - EXB

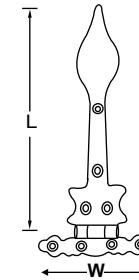

G0205 : BLACK ANTIQUE ORNATE CORONET HINGE



ITEM CODE	SIZE	LENGTH	WIDTH	SCREW NO.	WT/PCS	Pcs In Inner	Pcs In Outer
CHIN0205300	12"	290	108	7	0.260	10	60

Finish Available - EXB

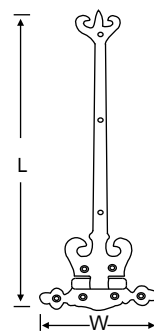

G0208 : BLACK ANTIQUE HEAVY PLAIN HINGE



ITEM CODE	SIZE	LENGTH	WIDTH	SCREW NO.	WT/PCS	Pcs In Inner	Pcs In Outer
CHIN0208375	14"	350	106	7	0.773	5	20

FINISH AVAILABLE - EXB

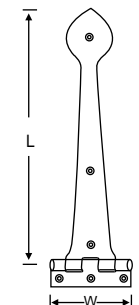

G0005 : BLACK ANTIQUE PLAIN HINGE



ITEM CODE	SIZE	LENGTH	WIDTH	SCREW NO.	WT/PCS	Pcs In Inner	Pcs In Outer
CHIN0005310	12"	275	100	8	0.527	5	30
CHIN0007390	16"	355	100	8	0.608	5	30
CHIN0009460	18"	450	100	8	0.738	5	20

FINISH AVAILABLE - EXB

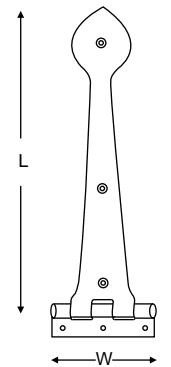

G0011 : BLACK ANTIQUE FLEUR - DE LYS CLAW HINGE



ITEM CODE	SIZE	LENGTH	WIDTH	SCREW NO.	WT/PCS	Pcs In Inner	Pcs In Outer
CHIN0011310	12"	270	100	8	0.708	5	20
CHIN0013390	16"	360	100	8	0.893	5	20
CHIN0015460	18"	430	100	8	0.913	5	20

FINISH AVAILABLE - EXB

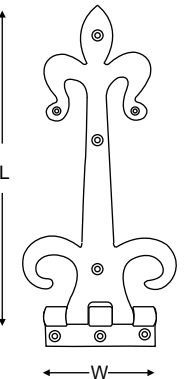

G0050 : BLACK ANTIQUE CLAW HINGE



ITEM CODE	SIZE	LENGTH	WIDTH	SCREW NO.	WT/PCS	Pcs In Inner	Pcs In Outer
CHIN0050385	14"	362	100	8	0.700	5	20

FINISH AVAILABLE - EXB

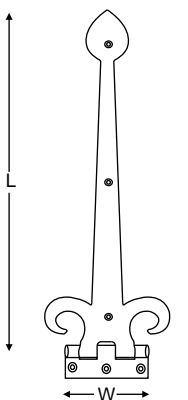



DESCRIPTION	PAGE	DESCRIPTION	PAGE
ADJUSTABLE HOOK AND BAND HINGE	20	HOOK AND BAND HINGE (CRANKED)	19
ANTIQUÉ CLAW HINGE (BLACK ANTIQUÉ)	40	HOOK ON BACK PLATE TO SUIT ADJ. BAND	21
BACK FLAP (TABLE) HINGE CRANKED KNUCKLE	8	HOOK ON BACK PLATE TO SUIT ADJ. BAND	21
BACK FLAP (TABLE) HINGE WITH BENT PIN	8	HOOKS AND BANDS HINGE (STRAIGHT)	18
BALL BEARING CE11 HINGE (STAINLESS STEEL)	25	HURLING HINGE-RADIUS CORNER	9
BALL BEARING CE13 HINGE (STAINLESS STEEL)	24	JOURNAL SUPPORT HINGE - HANDED	6
BALL BEARING CE7 HINGE (STAINLESS STEEL)	26	LIFT OFF HINGE - HANDED CRANKED KNUCKLE	3
BARREL HINGE	23	LIGHT DUTY HINGE (BLACK ANTIQUÉ)	39
BB BUTT HINGE (DOUBLE SECURITY PIN)	35	LIGHT HOOK AND BAND HINGE (CRANKED) LIGHT	20
BB SINGLE/DOUBLE SECURITY PINS HINGE(SSP/DSP)	27	NARROW BUTT HINGE UNCRANKED KNUCKLE F/P	1
BUTT HINGE WITH 2 BB & FINNIAL HEAD SS PIN (BRASS)	35	ORNATE CORONET HINGE (BLACK ANTIQUÉ)	39
BULLET HINGE	13	ORNATE CORONET HINGE (BLACK ANTIQUÉ)	39
BUTT HINGE - AUSTRALIAN SPECIFICATION	12	PARLIAMENT HINGE (BRASS)	37
BUTT HINGE (TOMB HEAD) (BRASS)	34	PARLIAMENT HINGE (BRASS)	37
BUTT HINGE 2/4 BEARINGS & BUTTON TIP PIN	7	PARLIAMENT HINGE (STAINLESS STEEL)	30
BUTT HINGE CRANKED KNUCKLE, FIXED PIN	1	PARLIAMENT HINGE UNCRANKED KNUCKLE F/P	4
BUTT HINGE CRANKED KNUCKLE, REMOVABLE PIN	1	PLAIN HINGE (BLACK ANTIQUÉ)	39
BUTT HINGE FRENCH SPECIFICATION	12	RADIUS CORNER HINGE - HANDED	4
BUTT HINGE WITH 2/4 BOTTON TIP HEAD SS PIN(BRASS)	33	RADIUS CORNER HINGE - HANDED(STAINLESS STEEL)	30
BUTT HINGE WITH 2/4 BOTTON TIP HEAD SS PIN(BRASS)	34	RADIUS CORNER ROUND HEAD(BRASS)	36
BUTT HINGE WITH DOUBLE STEEL WASHERS(BRASS)	32	REFLECT HINGE WITH FLAT FLUSH/ROUND HEAD	36
BUTT HINGES ACRON TIP SS PIN (BRASS)	35	REFLECT HINGE-HANDED (BRASS)	35
BUTT HINGES WITH DOUBLE SECURITY PIN	8	REFLUX HINGE (BRASS)	38
BUTT HINGESTAINLESS STEEL	28	REVERSIBLE HINGE (LIGHT WEIGHT)	21
BUTTER FLY HINGE (BLACK ANTIQUÉ)	38	REVERSIBLE HINGE WITH CAST IRON CUP	21
CABINET HINGE FIX PIN	10	REVERSIBLE HINGE(CUP ONLY)	22
CABINET HINGE SPRUNG (170 DEGREES)	23	RISING BUTT HINGE - HANDED	4
CABINET HINGE SPRUNG (26MM)	23	RISING BUTT HINGE - HANDED(STAINLESS STEEL)	29
CABINET HINGE SPRUNG (35MM)	23	SEAT HINGE	11
CABINET HINGE UNSPRUNG (26MM)	23	SHORT HINGE	22
CABINET HINGE UNSPRUNG (35MM)	23	SICHERN HINGE	28
CAST BUTT HINGE	2	SNAKE HINGE(BRASS)	38
CLIP ON CABINET HINGE SPRUNG (170 DEGREES)	23	SQUARE BUTT HINGE (BRASS)	34
CLIP ON CONCEALED HINGE 35MM (90 DEGREES)	23	SQUARE BUTT HINGE 2/4 BEARINGS	7
CONCEALED HINGE(GZC)	27	SQUARE BUTT HINGE FRENCH SPECIFICATION	12
CONTAINER HINGE	13	SQUARE BUTT HINGE WITH DOME HEAD PIN (BRASS)	34
CONTINUOUS PIANO HINGE	13	SQUARE HEAVY BUTT HINGE CRANKED KNUCKLE	7
CONTINUOUS PIANO HINGE (BRASS)	37	STAINLESS STEEL STRONG BUTT HINGE (S.S)	28
COUNTER HINGE (BRASS)(BRASS)	37	STRAP HINGE - HEAVY WEIGHT	18
CRANKED (EASY HANG) HINGE FIX PIN	10	STRAP HINGE - MEDIUM WEIGHT	17
CRANKED FLUSH HINGE	9	STRAP HINGE UNCRANKED KNUCKLE	17
CRANKED HINGE 2 BALL BEARING (SS PIN)(BRASS)	36	STROM PROOF HINGE WITH GAP(1951CR)	6
DOUBLE CRANKED HINGE FIX PIN	11	STROMPROOF HINGE (EXTRA HOLES)	5
DOUBLE PHOSPHOROUS BRONZE WASHERED HINGE	2	STROMPROOF BUTT HINGE	5
DOUBLE STEEL WASHERED HINGE	3	STROMPROOF HINGE	5
DOUBLE WASHERED - HEAVY DUTY(STAINLESS STEEL)	29	STRONG BUTT HINGE CRANKED KNUCKLE, F/P	2
DPBW BRASS HINGE (BRASS)	33	SUPPORTING HINGE OR OFFSET HINGE-HANDED	6
ESTATE PATTERN BAND	22	SUPPORTING HINGE(STAINLESS STEEL)	30
EXTRA STRONG DOUBLE FLAP BUTT HINGE	3	SURFACE MOUNT SPRUNG HINGE (100MM)	23
EXTRUDED BUTT HINGE (BRASS)	31	TABLE HINGE UNCRANKED FRENCH SPECIFICATION	9
FANCY CABINET HINGE (BUTTER FLY)	11	TEE HINGE (EXTRA STRONG WEIGHTY)	16
FLEUR-DE-LYS CLAW HINGE (BLACK ANTIQUÉ)	40	TEE HINGE (HEAVY SCOTCH)	16
FLUSH HINGE 2 BB & BUTTON TIP(STAINLESS STEEL)	29	TEE HINGE (MEDIUM PREMIUM)	15
FLUSH HINGE UNCRANKED KNUCKLE FIX PIN	10	TEE HINGE UNCRANKED KNUCKLE F/P (LIGHT PREMIUM)	14
GATE HOLD BACK HINGE/PENTURE DE GONDS	18	TEE HINGE UNCRANKED KNUCKLE FIX PIN (HEAVY)	15
H HINGE(BRASS)	36	TEE HINGE UNCRANKED KNUCKLE FIX PIN (LIGHT)	14
HEAVY HINGE (BLACK ANTIQUÉ)	40	TEE HINGE UNCRANKED KNUCKLE FIX PIN (MEDIUM)	14
HOOK AND BAND HINGE (CRANKED) PREMIUM	19	TEE HINGE UNCRANKED KNUCKLE FIX PIN(SCOTCH)	16
HOOK AND BAND HINGE (STRAIGHT)	20	TEE HINGE UNCRANKED KNUCKLE FIX PIN(STRONG)	15
HOOK AND BAND (DECORATIVE SQUARE TAIL)	22	TEE HINGE(GRADED)	17
HOOK AND BAND HINGE (PREMIUM)	19	UNEQUAL HINGE	38

CODE	PAGE	CODE	PAGE	CODE	PAGE
30	17	104FP	9	GB0101	37
36	13	1055L	20	GB1200	31
38	13	1056C/D	22	GB1300	32
101	13	1056L	20	GB1301	33
105	9	105SSBB	29	GB1351	34
106	10	112G	21	GB1401	33
108	10	119P	14	GB1405	34
109	11	120P	15	GB1500	34
118	9	121A	14	GB1501	34
119	16	121H	15	GB1601	35
120	15	121M	14	GB1701	35
128	19	195EH	5	GB1801	35
130	19	195FF	5	GB1811	38
140	21	3210SS	30	GB1901	36
234	18	400BP	8	GB2098	36
400	8	400UE	9	GB2201	35
451	2	451BB	7	GB2301	36
453	28	451DPBW	2	GB2400	36
457	3	451DSW	3	GB2451	38
459	6	451SS	28	GB3151	37
460	6	452DS/FP	8	GB3210	37
466	4	458RC	4	GB3210A	37
488	4	458SSRC	30	GF0251	23
499	21	459SS	30	GF101	23
804	12	466SS	29	GF102	23
867	16	499C	22	GF111	23
868	16	499LW	21	GF112	23
899	3	551BB	27	GF115	23
910	17	551SSBB	24	GF151	23
950	17	551SSBB	25	GF155	23
1055	18	551SSBB	26	GF201	23
1056	19	551W	29	GZC1201	27
1057	20	804BB	7		
1061	22	804H	7		
1386	11	950H	18		
1387	11	G0005	40		
1838	1	G0011	40		
1840	1	G0017	39		
1841	12	G0050	40		
1842	12	G0201	39		
1951	5	G0205	39		
2451	28	G0206	38		
3207	6	G0208	39		
5050	1	G1302	38		
7182	22	G-200	2		

NOTE

- * All Weight Given are Approximate and can Vary
- * All Data & Photos Printed In This Catalogue Represent The Product to Close Details, However There May Be Some Variations in Real Product & Photograph.
- * All Information and Photograph is Property of **D. P. GARG & CO. PVT. LTD.** It is illegal to reproduce any photograph & data without prior written consent of the company.

KEY FINISHES

SC	SELF COLOR
EXB	EPOXY BLACK
EXW	EPOXY WHITE
HSG	HOT SPLETER GALVANIZED DUROSIL
EB	ELECTRO BRASS
CP	CHROME PLATED ARJUNA
BZP	BRIGHT ZINC PLATED
YPZP	ZINC PLATED YELLOW PASIVATED
SNP	SATIN NICKEL PLATED
NP	NICKEL PLATED
ABR	ANTIQUÉ BRASS